

PRO-LIGHT

illuminazione tecnica a Led
Technical led lighting

Catalogo Prodotti
Product Catalogue

n°18

PRO-LIGHT

Pro-Light | © DG Tecnologie s.r.l.

www.pro-light.it

DG Tecnologie s.r.l.

Via Salvo D'Acquisto 42/F | 56025 Pontedera (PI) Italy

Tel. (+39) 0587 544 68

Tutti i diritti sono riservati. È vietata la riproduzione di testi e immagini.
All rights reserved. Reproduction of texts and images is prohibited.

Profilo aziendale

Company profile

Fondata negli anni 2000, da quasi due decenni DG Tecnologie è punto di riferimento nel fornire soluzioni di illuminazione per il settore del mobile, negozi, alberghi e civili abitazioni.

Nella sede centrale di Pisa l'azienda segue direttamente le fasi di progettazione, testing e coordinamento della produzione della merce, spesso realizzata sulla base delle specifiche tecniche desiderate dal cliente finale.

Anni di ricerca, prodotti dalla proverbiale affidabilità e l'abilità di fornire soluzioni su misura hanno permesso a DG Tecnologie di diventare con il tempo partner di importanti realtà internazionali, che hanno reso noto il suo brand illuminotecnico Pro-Light in Italia.

Founded in the 2000s, for almost two decades DG Tecnologie has been a point of reference in providing lighting solutions for the furniture sector, shops, hotels and residential buildings.

In the Pisa headquarters the company directly follows the design, testing and coordinates the phases of the products production, often created on the basis of the technical specifications desired by the end customer.

Years of research, reliable products and the ability to provide tailor-made solutions have allowed DG Tecnologie to become a partner of important international companies, which have made its Pro-Light lighting brand known in Italy.

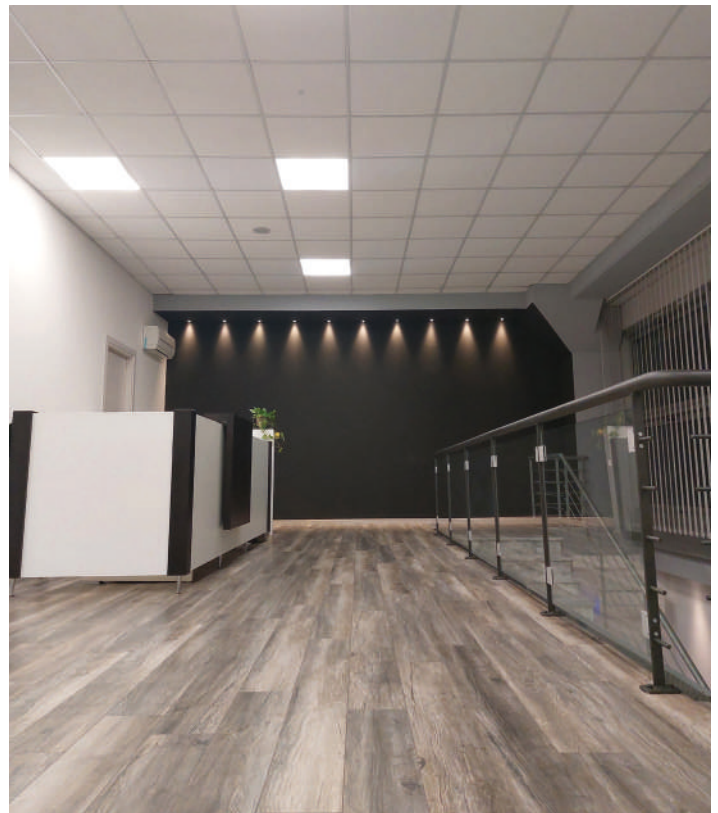

Uffici aziendali
Corporate offices



Profilo aziendale

Company profile

Componenti certificati secondo gli standard

Tutti i prodotti Pro-Light montano componentistica certificata e riconosciuta a livello internazionale, caratteristica che consente di ottenere un'affidabilità ai vertici del settore.

Components certified according to standards

All Pro-Light products are equipped with certified and internationally recognized components, a feature that allows for reliability at the top of the sector.



Programma di licenza Philips Enabled

DG Tecnologie, con il proprio marchio Pro-Light, è membro del club Philips Led Luminaires and Retrofit Bulbs Licensing program. Ciò permette all'azienda di vendere corpi illuminanti che includono componenti coperti da brevetti Philips.

Philips Enabled licensing program

DG Tecnologie, with its Pro-Light brand, is a member of the Philips Led Luminaires and Retrofit Bulbs Licensing program. This allows the company to sell lighting fixtures that include components covered by Philips patents.



Prodotti conformi alla direttiva EcoDesign

Tutti i prodotti di illuminazione Pro-Light sono conformi alle più recenti normative in materia di EcoDesign. Nei manuali di installazione Pro-light e nelle etichette energetiche è possibile trovare un QR code che consente rapido accesso al database interno dell'azienda, contenente tutti i dati riguardanti ogni prodotto in commercio.

Products compliant with the EcoDesign directive

All Pro-Light lighting products comply with the latest EcoDesign regulations. In the Pro-light installation manuals and energy labels it is possible to find a QR code that allows quick access to the company's internal database, containing all the data regarding each product on the market.

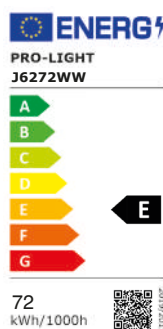

Profilo aziendale

Company profile

Canale dedicato B2B e listino certificato

Offriamo ai rivenditori la possibilità di ricevere un account che consenta di emettere rapidamente gli ordini dal sito web Pro-Light, controllando in tempo reale disponibilità e prezzi dedicati. Il listino DG Tecnologie è inoltre certificato METEL, consentendo l'inserimento rapido dei prodotti all'interno del database dei clienti.

Dedicated B2B channel and METEL certified price list

We offer resellers the possibility of receiving an account that allows them to quickly place orders from the Pro-Light website, checking availability and dedicated prices in real time. The DG Tecnologie price list is also METEL certified, allowing the rapid insertion of products into the customer database.

Supporto commerciale tempestivo

Pro-Light mette a disposizione dei clienti un Back Office dedicato, in grado di offrire supporto commerciale tempestivo, emettere preventivi, inoltrare schede tecniche e confermare i tempi di consegna di ogni ordine emesso.

Timely commercial support

Pro-Light provides customers with a dedicated Back Office, capable of offering timely commercial support, issuing estimates, forwarding technical data sheets and confirming the delivery times of each shipment.

Supporto tecnico avanzato

L'azienda dispone al suo interno di tecnici specializzati in grado di risolvere ogni dubbio in merito alle caratteristiche tecniche dei prodotti, alla loro installazione e ai sistemi di controllo compatibili. Lo staff aziendale è sempre disponibile per organizzare incontri formativi ed eseguire calcoli illuminotecnici.

Advanced technical support

The company has specialized technicians capable of resolving any doubts regarding the technical characteristics of the products, their installation and compatible control systems. The company staff is always available to organize training meetings and carry out lighting calculations.

Consegne rapide

L'azienda si avvale di un'efficiente rete logistica con servizi di spedizione Express, in modo da garantire la consegna non dopo le 48h dall'emissione dell'ordine.

Quick deliveries

The company uses an efficient logistics network with Express shipping services, in order to guarantee delivery no later than 48 hours after placing the order.

Index Strip Series

Cob Fascio di luce continuo e CRI elevato / Continuous beam of light and high CRI

→ p. 16



J6045

J6080

J6180

Ultra Alta densità, dissipazione ottimale e CRI elevato / High density, optimal heat dissipation and high CRI

→ p. 17

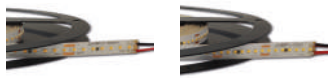

J6272

J6297

Over Alta efficienza / High efficiency

→ p. 18



J6382

J6383

J6384

J6385

Plus Basilare e affidabile / Basic and reliable

→ p. 20



J4248

J4272

J4296

J4348

J4372

J4396

Special Caratteristiche speciali / Special features

→ p. 21



J6387

J4572

J5060

J5064

J5050

J6345

J9748



J9872

J9875

J5160

J5005

J5024

Connections Prolunghe ed elementi di connessione / Extensions and connection elements

→ p. 30



Jxx1

Jxx3

J11

J14

J26

J26C

J26E



JPL

JCAT

JCAR

Index Profile Series

Alu

→ p. 38

Profilo in alluminio per strip led / Aluminium profile for led strips

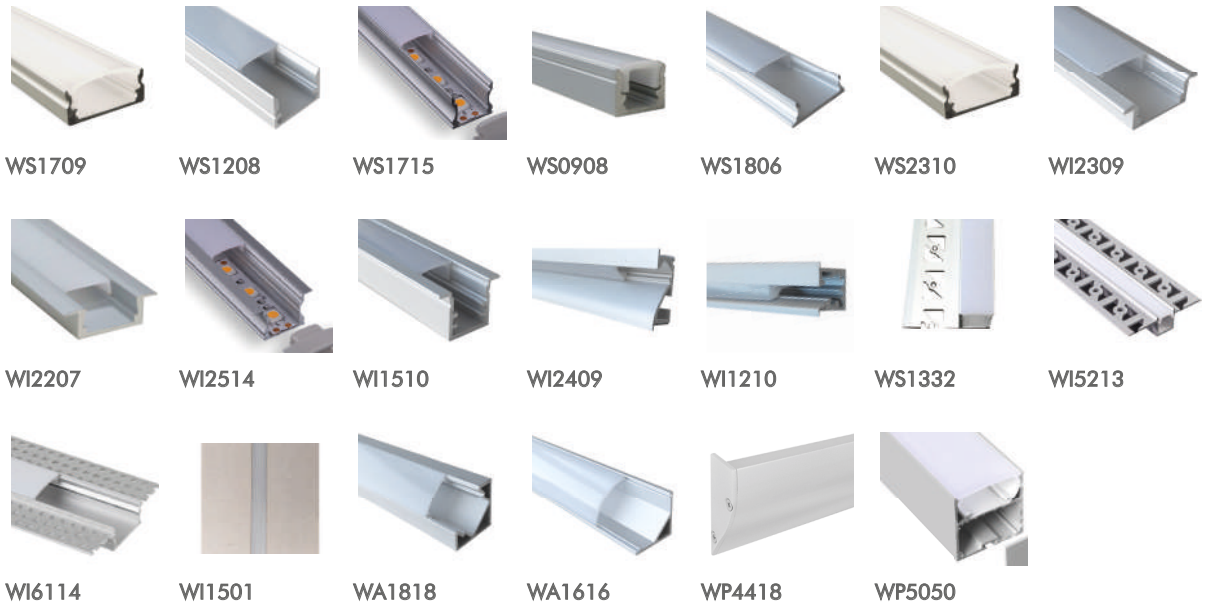

Xps

→ p. 78

Profilo in XPS / XPS profile

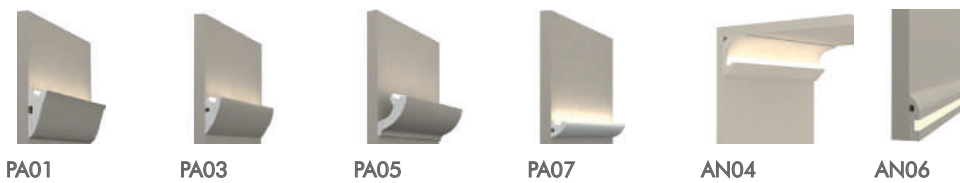

Myway

→ p. 82

Prodotto finito realizzato su misura / Tailor made finished product

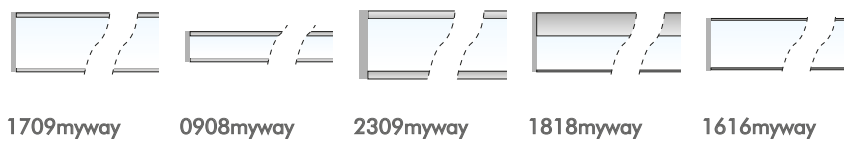

Index Residential Series

Smart

→ p. 96

Faretto downlight / Downlight

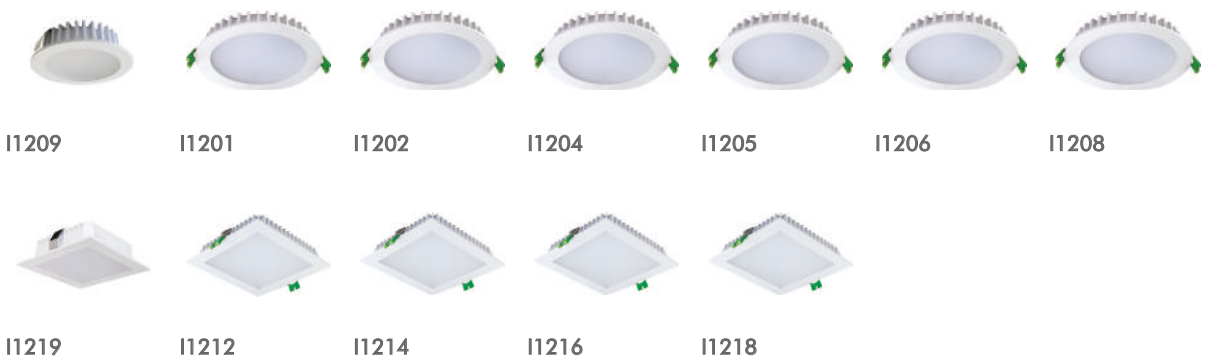

Modulo

→ p. 98

Faretto downlight modulare / Modular spotlight



Mini

→ p. 108

Faretto mini / Mini downlight



Advance

→ p. 122

Faretto downlight / Downlight



Index Retail Series

Spot

→ p. 128

Faretto downlight / Downlight



Track

→ p. 130

Binario trifase / 3-phase track

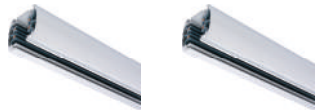

T_322

T_323

Tracklight

→ p. 132

Fari per binario trifase / 3-phase track lights



R4_81

R4_83

R4_85

R4_25

R4_35

R3_85

R0060



R0150



R472

Index Office Series

Panel

→ p. 142

Pannello led / Led panel



U6545

U6550

U6650

Linear System

→ p. 146

Luce lineare / Linear light



S50

S75

Index Industrial Series

High bay

→ p. 150

Plafone led / High bay



M1410

M1415

M1420

Plafò

→ p. 151

Plafoniera led / Led batten



U3062

U3122

U3152

Flood

→ p. 152

Proiettore led / Led flood light



B2020

B2030

B2050

B2100

B2150

B2200

B3050

B3100

B3150

B3200

Index Garden Series

Surface

→ p. 156

Faretto da esterno / Outdoor spotlight



D4003

D4007

D4012

D4230

Inground

→ p. 158

Faretto da esterno / Outdoor spotlight



E1903

E2003

E1913

E2103

E2013

E2023

E2033

E3107

E3115

Index Driver Series

CV led

→ p. 164

Driver led in tensione costante / Constant voltage led drivers



FMT

RBV

BMT

LNT

APV

LPV

XLG

ELG

ELG-B

ELG-DA

CC led

Driver led in corrente costante / Constant current led drivers

→ p. 168



APC

LPC

LCM

LCM-DA

FLS

Industrial

Driver industriali / Drivers for industrial applications

→ p. 170



LRS

RSP

NDR

SDR

KNX

Index Controllers Series

Mini Ignitions

Mini accensioni per strip led / Mini ignitions for LED strips

→ p. 172



A3051

A3053

A3056

A3060

Professional

Controller led professionali / Professional led controllers

→ p. 174



Push-cv

Push-4cv

Push-230

Phase-cut

Dali-cv

Dali-4cv

Dali-wifi

Dmx-cv

Dmx-4cv

Radio-push

Radio-cv

Matter-cv

Matter-230

Forrest-spi

RF

Controller led in radiofrequenza / Radio frequency led controllers

→ p. 178



V1

V1H

V4

WT1

WT5

SC

V2



R1_

R_RU_

R1-1_

RT_

RT2-RT7

RT4-RT9

RS1-RS2



R9

Strip Series

Strip led / Led strips

Superficie, incasso e sospensione / Surface, recessed and suspension

Strip series

Cob

Fascio di luce continuo e CRI elevato / Continuous beam of light and high CRI



J6045

J6080

J6180

Ultra

Alta densità, dissipazione ottimale e CRI elevato / High density, optimal heat dissipation and high CRI

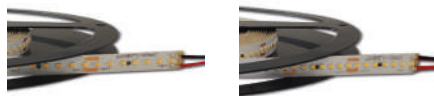

J6272

J6297

Over

Alta efficienza / High efficiency



J6382

J6383

J6384

J6385

Plus

Basilare e affidabile / Basic and reliable



J4248

J4272

J4296

J4348

J4372



J4396

Strip series

Strip led / Led strips

Superficie, incasso e sospensione / Surface, recessed and suspension

Strip series

Special

Caratteristiche speciali / Special features



J6387



J4572



J5060



J5064



J5050



J6345



J9748



J9872



J9875



J5160



J5005



J5024

Connections

Prolunghe ed elementi di connessione / Extensions and connection elements



Jxx1



Jxx3



J11



J14



J26



J26C



J26E



JPL



JCAT



JCAR

IP20

1 Color Standard

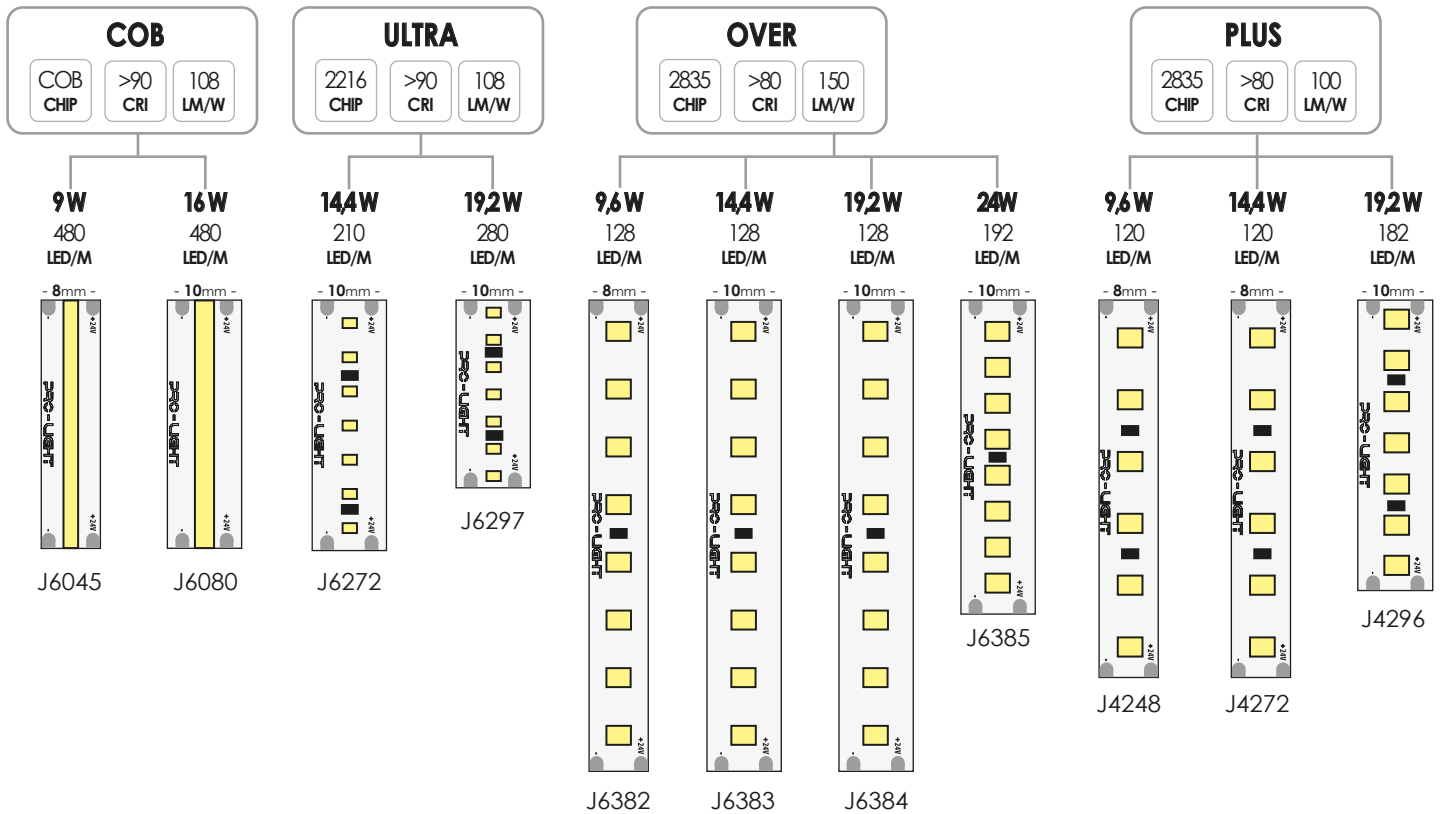

Special & Multicolor

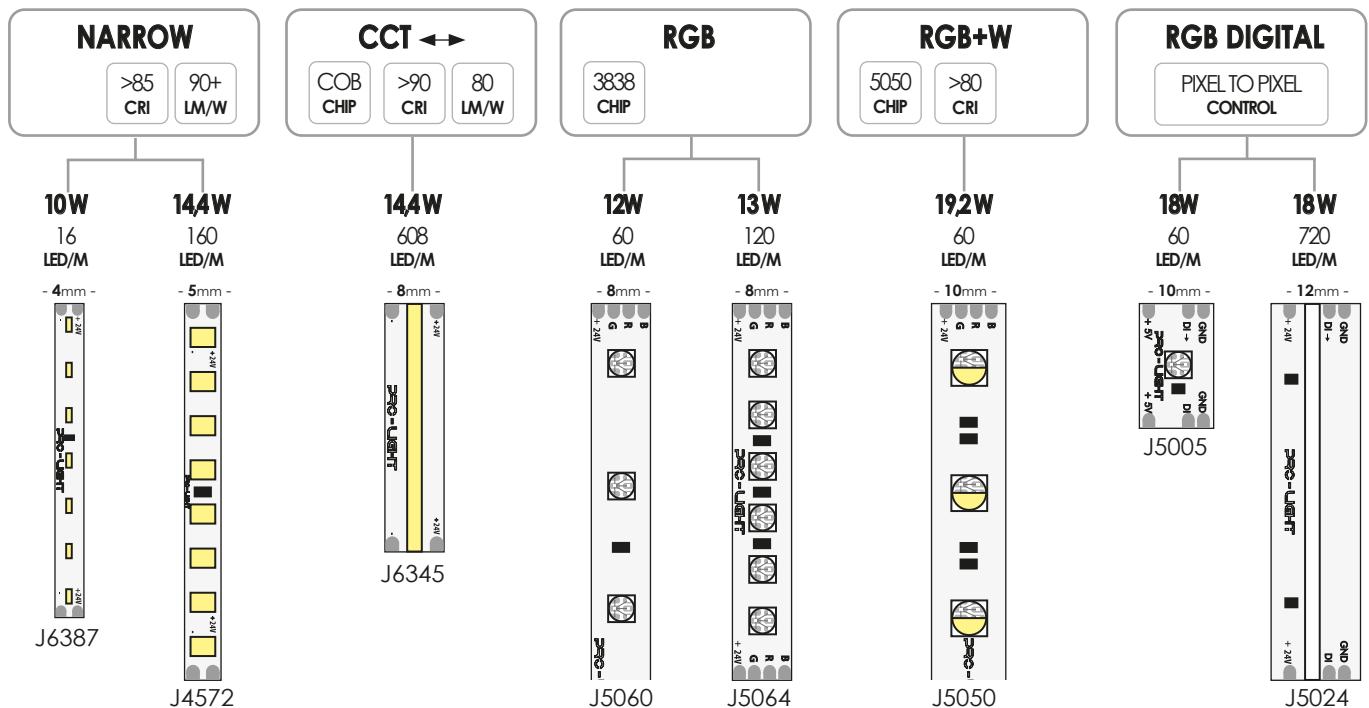

IP65+

1 Color Standard

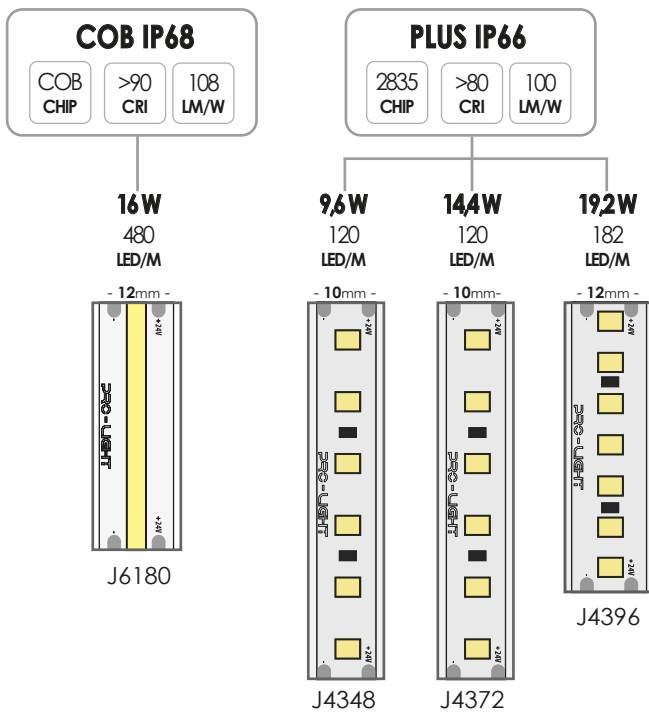

Special & Multicolor

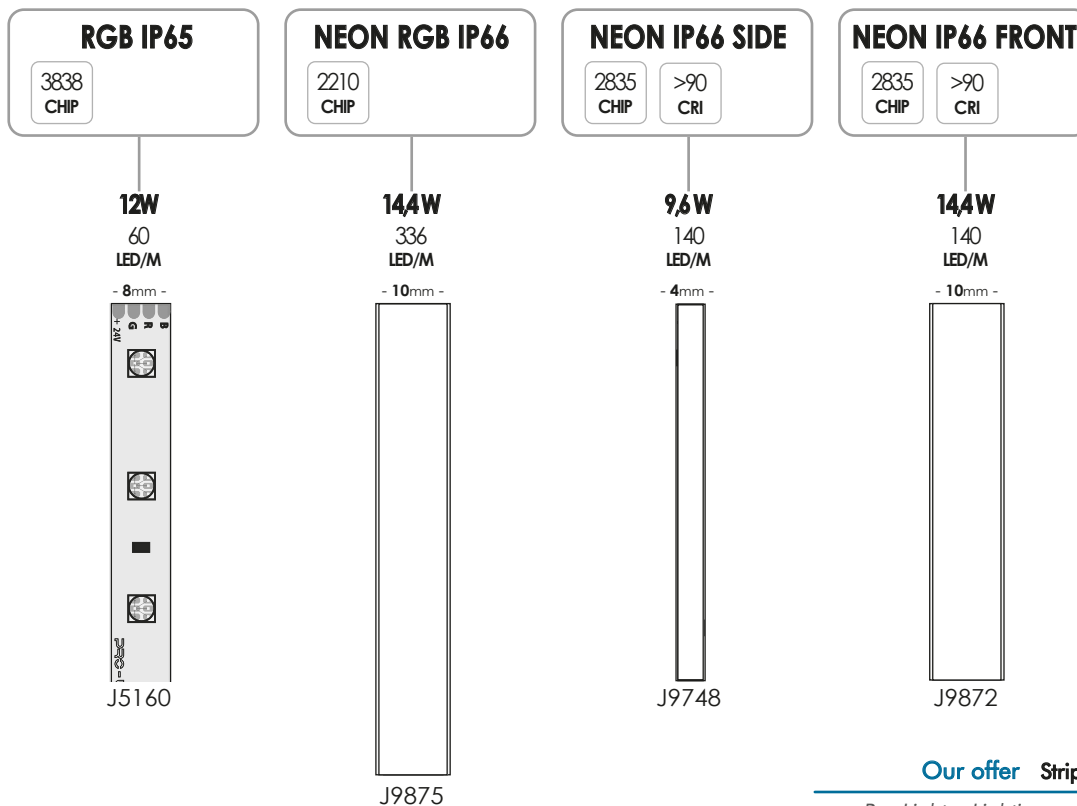

J6045

IP20

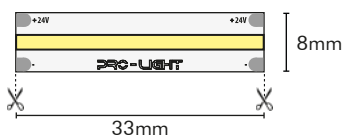

J6045 ————— ● Reel 5000mm

°K	W/m	Chip	Led/m	Lumen/m	Cri	IP	V in	L (mm)	Cod.
2700°K*	9,0	COB	480	790	>90	IP20	24V	5000	J6045HW
3000°K	9,0	COB	480	830	>90	IP20	24V	5000	J6045WW
4000°K	9,0	COB	480	890	>90	IP20	24V	5000	J6045NW
6000°K*	9,0	COB	480	890	>90	IP20	24V	5000	J6045CW

* Su richiesta / Upon request

Bobina da 25m disponibile su richiesta / 25m reel available upon request

Strip Led / Led Strip

Cob - Strip series

COB series

- COB
- Cri > 90
- 95lm/W
- IP20

Cablaggio opzionale Optional wiring

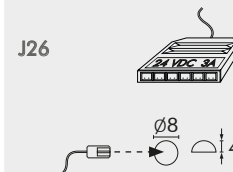
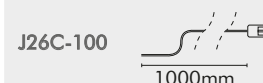

J6080

IP20

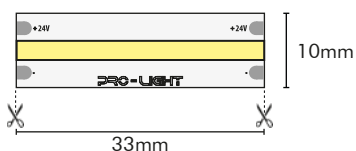

J6080 ————— ● Reel 5000mm

°K	W/m	Chip	Led/m	Lumen/m	Cri	IP	V in	L (mm)	Cod.
2700°K*	16,0	COB	480	1404	>90	IP20	24V	5000	J6080HW
3000°K	16,0	COB	480	1475	>90	IP20	24V	5000	J6080WW
4000°K	16,0	COB	480	1580	>90	IP20	24V	5000	J6080NW
6000°K*	16,0	COB	480	1580	>90	IP20	24V	5000	J6080CW

* Su richiesta / Upon request

Bobina da 25m disponibile su richiesta / 25m reel available upon request

Strip Led / Led Strip

Cob - Strip series

COB series

- COB
- Cri > 90
- 95lm/W
- IP20

Cablaggio opzionale Optional wiring

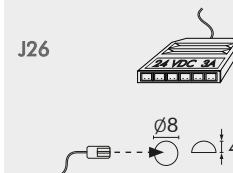
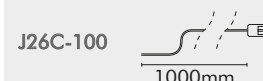

J6272

IP20

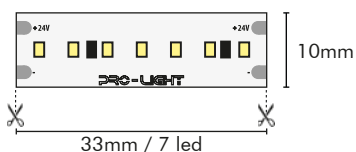
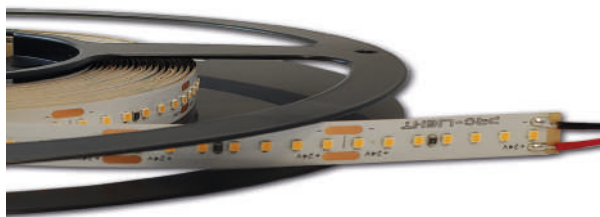

J6272 ————— ● Reel 5000mm

°K	W/m	Chip	Led/m	Lumen/m	Cri	IP	V in	L (mm)	Cod.
2700°K	14,4	2216	210	1425	>92	IP20	24V	5000	J6272HW
3000°K	14,4	2216	210	1468	>92	IP20	24V	5000	J6272WW
4000°K	14,4	2216	210	1584	>92	IP20	24V	5000	J6272NW
5000°K	14,4	2216	210	1584	>92	IP20	24V	5000	J6272PW
6000°K	14,4	2216	210	1584	>92	IP20	24V	5000	J6272CW

Bobina da 25m disponibile su richiesta / 25m reel available upon request

Strip Led / Led Strip

Ultra - Strip series

ULTRA series

- 2116
- Cri > 92
- 110lm/W
- IP20

Cablaggio opzionale Optional wiring

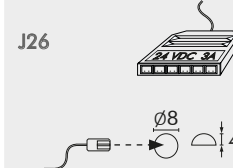

J6297

IP20

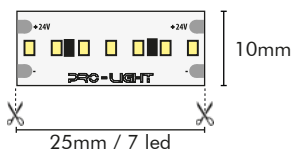
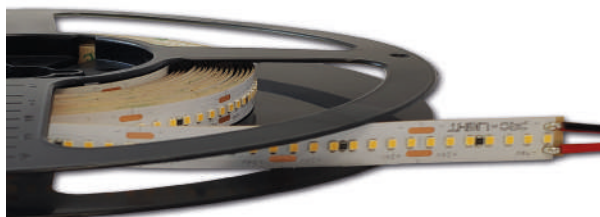

J6297 ————— ● Reel 5000mm

°K	W/m	Chip	Led/m	Lumen/m	Cri	IP	V in	L (mm)	Cod.
2700°K	19,2	2216	280	1812	>92	IP20	24V	5000	J6297HW
3000°K	19,2	2216	280	1862	>92	IP20	24V	5000	J6297WW
4000°K	19,2	2216	280	1958	>92	IP20	24V	5000	J6297NW
6000°K	19,2	2216	280	1958	>92	IP20	24V	5000	J6297CW

Bobina da 25m disponibile su richiesta / 25m reel available upon request

Strip Led / Led Strip

Ultra - Strip series

ULTRA series

- 2216
- Cri > 92
- 110lm/W
- IP20

Cablaggio opzionale Optional wiring

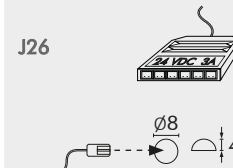

J6382

IP20

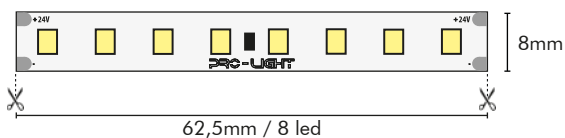

J6382 ————— ● Reel 5000mm

°K	W/m	Chip	Led/m	Lumen/m	Cri	IP	V in	L (mm)	Cod.
3000°K	9,6	2835	128	1344	>80	IP20	24V	5000	J6382WW
4000°K	9,6	2835	128	1440	>80	IP20	24V	5000	J6382NW

Strip Led / Led Strip

Over - Strip series

OVER series

- 2835
- Cri > 80
- 150lm/W
- IP20

Cablaggio opzionale Optional wiring

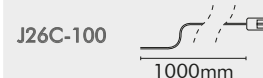

J6383

IP20

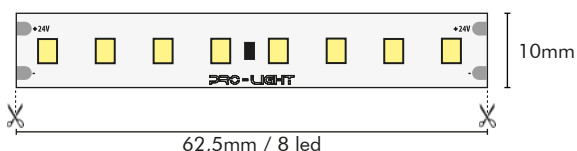

J6383 ————— ● Reel 5000mm

°K	W/m	Chip	Led/m	Lumen/m	Cri	IP	V in	L (mm)	Cod.
3000°K	14,4	2835	128	1963	>80	IP20	24V	5000	J6383WW
4000°K	14,4	2835	128	2018	>80	IP20	24V	5000	J6383NW

Strip Led / Led Strip

Over - Strip series

OVER series

- 2835
- Cri > 80
- 150lm/W
- IP20

Cablaggio opzionale Optional wiring

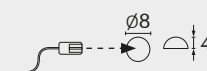
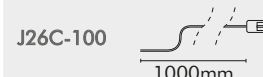

J6384

IP20

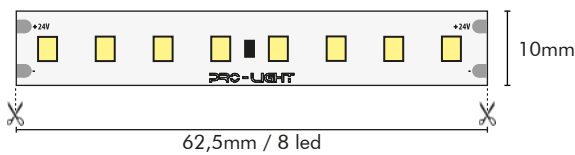

J6384 ————— ● Reel 5000mm

°K	W/m	Chip	Led/m	Lumen/m	Cri	IP	V in	L (mm)	Cod.
3000°K	19,2	2835	128	2592	>80	IP20	24V	5000	J6384WW
4000°K	19,2	2835	128	2688	>80	IP20	24V	5000	J6384NW

Strip Led / Led Strip

Over - Strip series

OVER series

- 2835
- Cri > 80
- 150lm/W
- IP20

Cablaggio opzionale Optional wiring

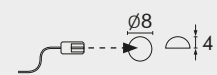
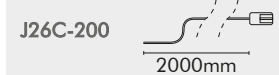
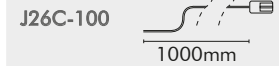

J6385

IP20

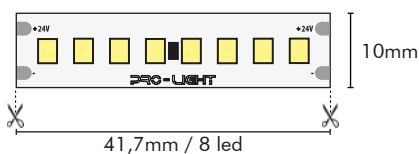

J6385 ————— ● Reel 5000mm

°K	W/m	Chip	Led/m	Lumen/m	Cri	IP	V in	L (mm)	Cod.
3000°K	24,0	2835	192	3240	>80	IP20	24V	5000	J6385WW
4000°K	24,0	2835	192	3360	>80	IP20	24V	5000	J6385NW

Strip Led / Led Strip

Over - Strip series

OVER series

- 2835
- Cri > 80
- 150lm/W
- IP20

Cablaggio opzionale Optional wiring

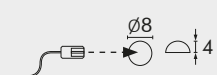
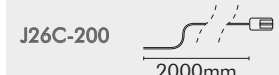
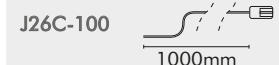

J4248

IP20

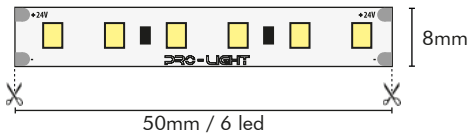

J4248 ————— ● Reel 5000mm

°K	W/m	Chip	Led/m	Lumen/m	Cri	IP	V in	L (mm)	Cod.
2700°K	9,6	2835	120	850	>80	IP20	24V	5000	J4248HW
3000°K	9,6	2835	120	900	>80	IP20	24V	5000	J4248WW
4000°K	9,6	2835	120	960	>80	IP20	24V	5000	J4248NW
6000°K*	9,6	2835	120	960	>80	IP20	24V	5000	J4248CW

* Su richiesta / Upon request

Disponibile 12V su richiesta / 12V available upon request

Bobina da 25m disponibile su richiesta / 25m reel available upon request

Strip Led / Led Strip

Plus - Strip series

PLUS series

- 2835
- Cri > 80
- 100lm/W
- IP20

Cablaggio opzionale Optional wiring

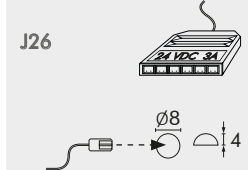
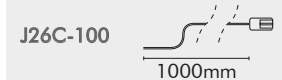

J4272

IP20

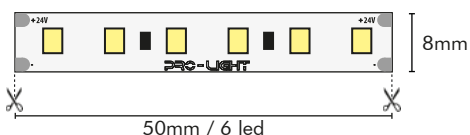

J4272 ————— ● Reel 5000mm

°K	W/m	Chip	Led/m	Lumen/m	Cri	IP	V in	L (mm)	Cod.
2700°K	14,4	2835	120	1275	>80	IP20	24V	5000	J4272HW
3000°K	14,4	2835	120	1400	>80	IP20	24V	5000	J4272WW
4000°K	14,4	2835	120	1440	>80	IP20	24V	5000	J4272NW
6000°K*	14,4	2835	120	1440	>80	IP20	24V	5000	J4272CW

* Su richiesta / Upon request

Disponibile 12V su richiesta / 12V available upon request

Bobina da 25m disponibile su richiesta / 25m reel available upon request

Strip Led / Led Strip

Plus - Strip series

PLUS series

- 2835
- Cri > 80
- 100lm/W
- IP20

Cablaggio opzionale Optional wiring

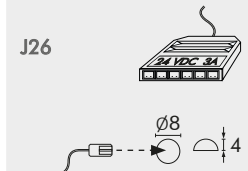
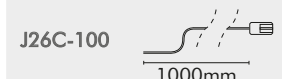

J4296

IP20

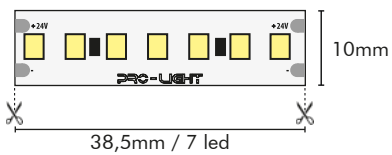

J4296 ————— ● Reel 5000mm

°K	W/m	Chip	Led/m	Lumen/m	Cri	IP	V in	L (mm)	Cod.
2700°K*	19,2	2835	182	1700	>80	IP20	24V	5000	J4296HW
3000°K	19,2	2835	182	1800	>80	IP20	24V	5000	J4296WW
4000°K	19,2	2835	182	1920	>80	IP20	24V	5000	J4296NW
6000°K*	19,2	2835	182	1920	>80	IP20	24V	5000	J4296CW

* Su richiesta / Upon request
 Disponibile 12V su richiesta / 12V available upon request
 Bobina da 25m disponibile su richiesta / 25m reel available upon request

Strip Led / Led Strip

Plus - Strip series

PLUS series

- 2835
- Cri > 80
- 100lm/W
- IP20

Cablaggio opzionale Optional wiring

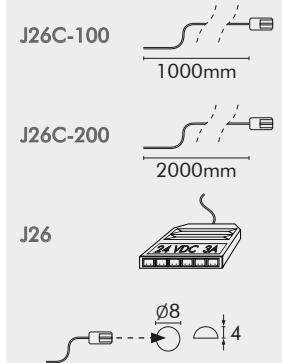

J6387

IP20

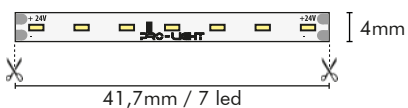

J6387 ————— ● Reel 5000mm

°K	W/m	Chip	Led/m	Lumen/m	Cri	IP	V in	L (mm)	Cod.
2700°K*	10,0	2110	168	850	>90	IP20	24V	5000	J6387HW
3000°K	10,0	2110	168	900	>90	IP20	24V	5000	J6387WW
4000°K	10,0	2110	168	960	>90	IP20	24V	5000	J6387NW
6000°K*	10,0	2110	168	960	>90	IP20	24V	5000	J6387CW

* Su richiesta / Upon request

Strip Led / Led Strip

Special - Strip series

NARROW

- 2110
- Cri > 90
- 90lm/W
- IP20

Cablaggio opzionale Optional wiring

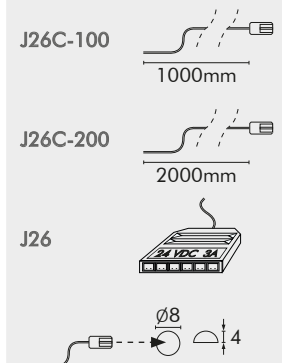

J4572

IP20

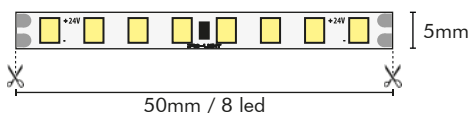

J4572 ————— ● Reel 5000mm

°K	W/m	Chip	Led/m	Lumen/m	Cri	IP	V in	L (mm)	Cod.
2700°K	14,4	2835	160	2000	>80	IP20	24V	5000	J4572HW
3000°K	14,4	2835	160	2088	>80	IP20	24V	5000	J4572WW
4000°K	14,4	2835	160	2160	>80	IP20	24V	5000	J4572NW
6000°K*	14,4	2835	160	2160	>80	IP20	24V	5000	J4572CW

* Su richiesta / Upon request

Strip Led / Led Strip

Special - Strip series

NARROW

- 2835
- Cri > 80
- 150lm/W
- IP20

Cablaggio opzionale
Optional wiring

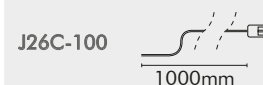

J5060

IP20



J5060 ————— ● Reel 5000mm

°K	W/m	Chip	Led/m	Cri	IP	V in	L (mm)	Cod.
RGB	12,0	3838	60	>90	IP20	24V	5000	J5060Z

Strip Led / Led Strip

Special - Strip series

RGB

- 3838
- RGB
- 60led/m
- IP20



J5064

IP20

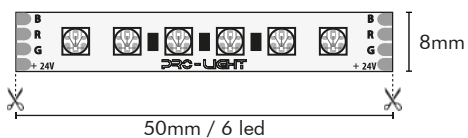

J5064 ————— ● Reel 5000mm

°K	W/m	Chip	Led/m	Cri	IP	V in	L (mm)	Cod.
RGB	13,0	3838	120	>90	IP20	24V	5000	J5064Z

Strip Led / Led Strip

Special - Strip series

RGB

- 3838
- 120led/m
- RGB
- IP20



RGB

J5050

IP20

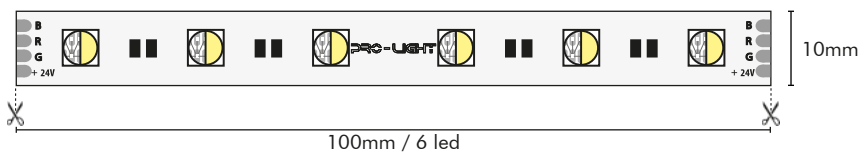

J5050 ————— ● Reel 5000mm

°K	W/m	Chip	Led/m	Cri	IP	V in	L (mm)	Cod.
RGB + 3000°K	19,2	5050	60	>90	IP20	24V	5000	J5050ZW
RGB + 4000°K	19,2	5050	60	>90	IP20	24V	5000	J5050ZN

Strip Led / Led Strip

Special - Strip series

RGB + W

- 5050
- 60led/m
- RGB+W
- IP20



RGB



3000°K
4000°K

J6345

IP20

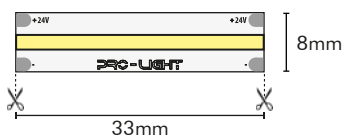
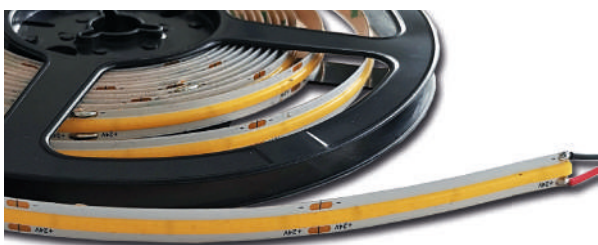

J6345 ————— ● Reel 5000mm

°K	W/m	Chip	Led/m	Lumen/m	Cri	IP	V in	L (mm)	Cod.
2700°K ↔ 6500°K	14,4	COB	608	1224	>90	IP20	24V	5000	J6345RW

Strip Led / Led Strip

Special - Strip series

CCT ↔

- COB
- Cri > 90
- 85lm/W
- IP20

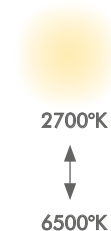

J5005

IP20

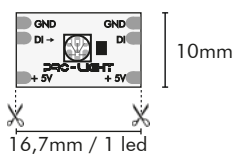

J5005 ————— ● Reel 5000mm

°K	W/m	Chip	Led/m	IC type	Cri	IP	V in	L (mm)	Cod.
RGB	18,0	5050	60	WS2812	>90	IP20	5V	5000	J5005SZ

Strip Led / Led Strip

Special - Strip series

RGB DIGITAL

- 5050
- RGB
- 60led/m
- IP20



Controllo digitale Pixel to Pixel
Pixel to Pixel digital control

J5024

IP20

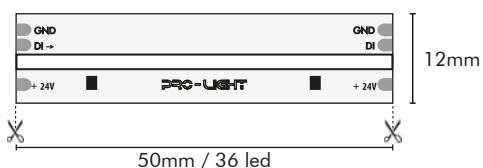

J5024 ————— ● Reel 5000mm

°K	W/m	Chip	Led/m	IC type	Cri	IP	V in	L (mm)	Cod.
RGB	18,0	COB	720	WS2811	>90	IP20	24V	5000	J5024SZ

Strip Led / Led Strip

Special - Strip series

RGB DIGITAL

- COB
- RGB
- 720led/m
- IP20



Controllo digitale Pixel to Pixel
Pixel to Pixel digital control

J4348

IP66

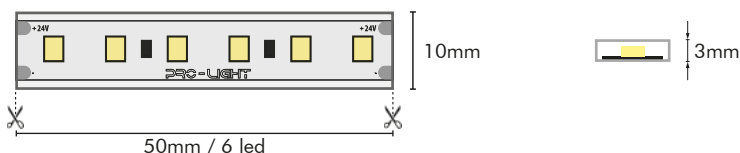
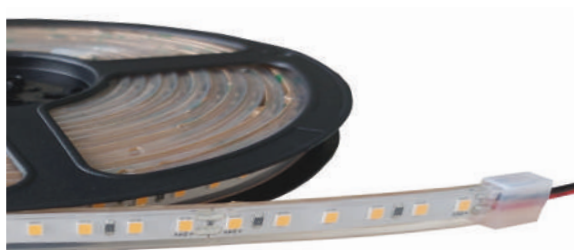

J4348 ————— ● Reel 5000mm

°K	W/m	Chip	Led/m	Lumen/m	Cri	IP	V in	L (mm)	Cod.
2700°K*	9,6	2835	120	850	>80	IP66	24V	5000	J4348HW
3000°K	9,6	2835	120	900	>80	IP66	24V	5000	J4348WW
4000°K	9,6	2835	120	960	>80	IP66	24V	5000	J4348NW
6000°K*	9,6	2835	120	960	>80	IP66	24V	5000	J4348CW

Strip Led / Led Strip

Plus - Strip series

PLUS series

- 2835
- Cri>80
- 100lm/W
- IP66

Accessori Accessories

- J43-T Tappo
End cap
- J43-TC Tappo forato
End cap w.hole

* Su richiesta / Upon request
Disponibile 12V su richiesta / 12V available upon request

J4372

IP66

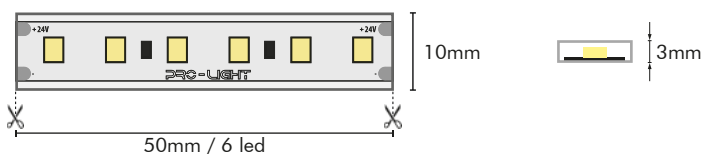
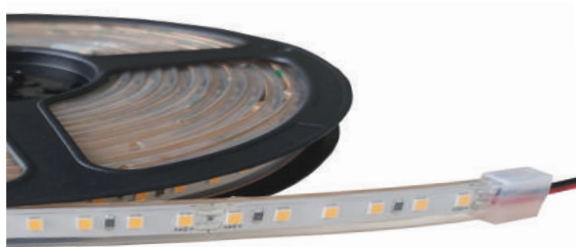

J4372 ————— ● Reel 5000mm

°K	W/m	Chip	Led/m	Lumen/m	Cri	IP	V in	L (mm)	Cod.
2700°K	14,4	2835	120	1275	>80	IP66	24V	5000	J4372HW
3000°K	14,4	2835	120	1400	>80	IP66	24V	5000	J4372WW
4000°K	14,4	2835	120	1440	>80	IP66	24V	5000	J4372NW
6000°K*	14,4	2835	120	1440	>80	IP66	24V	5000	J4372CW

* Su richiesta / Upon request
Disponibile 12V su richiesta / 12V available upon request

Strip Led / Led Strip

Plus - Strip series

PLUS series

- 2835
- Cri>80
- 100lm/W
- IP66

Accessori Accessories

- J43-T Tappo
End cap
- J43-TC Tappo forato
End cap w.hole

J4396

IP66

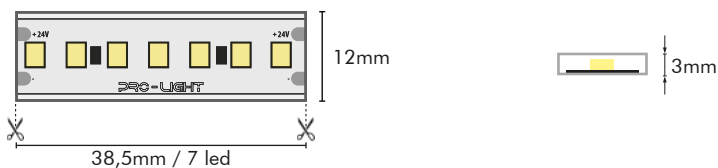

J4396 ————— ● Reel 5000mm

°K	W/m	Chip	Led/m	Lumen/m	Cri	IP	V in	L (mm)	Cod.
2700°K*	19,2	2835	182	1700	>80	IP66	24V	5000	J4396HW
3000°K	19,2	2835	182	1800	>80	IP66	24V	5000	J4396WW
4000°K	19,2	2835	182	1920	>80	IP66	24V	5000	J4396NW
6000°K*	19,2	2835	182	1920	>80	IP66	24V	5000	J4396CW

* Su richiesta / Upon request
Disponibile 12V su richiesta / 12V available upon request

Strip Led / Led Strip

Plus - Strip series

PLUS series

- 2835
- Cri>80
- 100lm/W
- IP66

Accessori Accessories

- J43-T2 Tappo
End cap
- J43-TC2 Tappo forato
End cap w.hole

J6180

IP20

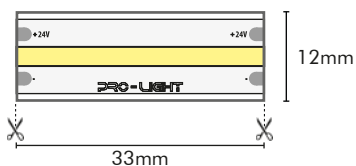
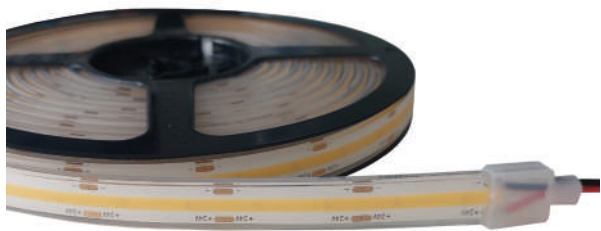

J6180 ————— ● Reel 5000mm

°K	W/m	Chip	Led/m	Lumen/m	Cri	IP	V in	L (mm)	Cod.
2700°K*	16,0	COB	480	1404	>90	IP68	24V	5000	J6180HW
3000°K	16,0	COB	480	1475	>90	IP68	24V	5000	J6180WW
4000°K	16,0	COB	480	1580	>90	IP68	24V	5000	J6180NW
6000°K*	16,0	COB	480	1580	>90	IP68	24V	5000	J6180CW

* Su richiesta / Upon request

Strip Led / Led Strip

Cob - Strip series

COB series

- COB
- Cri > 90
- 95lm/W
- IP68

Accessori Accessories

- J6180-C **Clip fissaggio**
Securing clip
- J6180-T **Tappo**
End cap
- J6180-TC **Tappo forato**
End cap w.hole

J9748

IP66

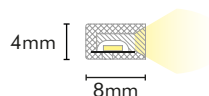
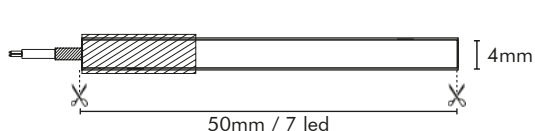

J9748 ————— ● Reel 5000mm

°K	W/m	Chip	Led/m	Lumen/m	Cri	IP	V in	L (mm)	Cod.
3000°K	9,6	2835	140	173	>90	IP66	24V	5000	J9748WW
4000°K	9,6	2835	140	211	>90	IP66	24V	5000	J9748NW

Strip Led / Led Strip

Special - Strip series

NEON

- 2835
- Cri > 90
- 140led/m
- IP66

Accessori Accessories

- J9748-C **Clip fissaggio**
Securing clip
- J9748-T **Tappo**
End cap
- J9748-TC **Tappo forato**
End cap w.hole

J9872

IP66

Strip Led / Led Strip

Special - Strip series

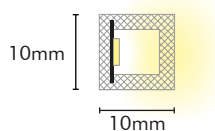
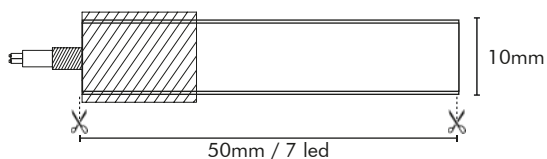

NEON

- 2835
- Cri > 90
- 140led/m
- IP66

Accessori Accessories

- J9872-C **Clip fissaggio**
Securing clip
- J9872-T **Tappo**
End cap
- J9872-TC **Tappo forato**
End cap w.hole

J9872 — Reel 5000mm

°K	W/m	Chip	Led/m	Lumen/m	Cri	IP	V in	L (mm)	Cod.
3000°K	14,4	2835	140	763	>90	IP66	24V	5000	J9872WW
4000°K	14,4	2835	140	864	>90	IP66	24V	5000	J9872NW

J9875

IP66

Strip Led / Led Strip

Special - Strip series

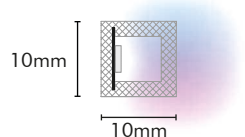
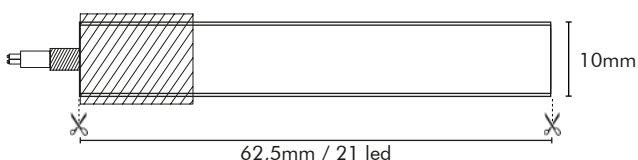

NEON

- 2110
- RGB
- 336led/m
- IP66

Accessori Accessories

- J9872-C **Clip fissaggio**
Securing clip
- J9872-T **Tappo**
End cap
- J9872-TC **Tappo forato**
End cap w.hole

J9875 — Reel 5000mm

°K	W/m	Chip	Led/m	Cri	IP	V in	L (mm)	Cod.
RGB	14,4	2110	336	>90	IP66	24V	5000	J9875Z

J5160

IP65

Strip Led / Led Strip

Special - Strip series



RGB

- 3838
- 60led/m
- RGB
- IP65

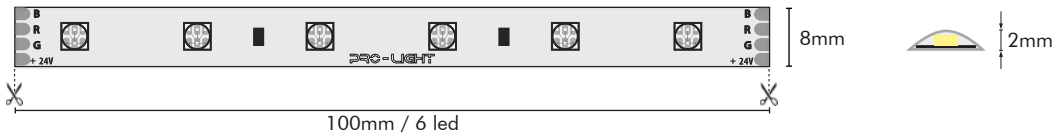

J5160 — Reel 5000mm

°K	W/m	Chip	Led/m	Cri	IP	V in	L (mm)	Cod.
RGB	12,0	3838	60	>90	IP65	24V	5000	J5160Z

J081/J101

Prolunghe ed elementi di connessione / Extensions and connection elements

IP20

Connections - Strip series



Codice prodotto Item code	Larghezza strip Strip width
J081	8mm
J101	10mm

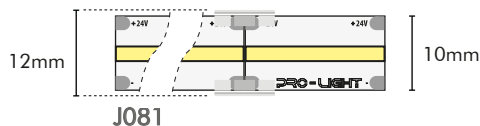
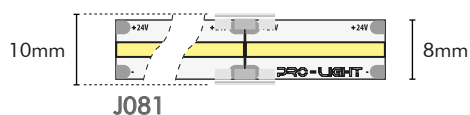

J081/J101 — Connections series

Connettore trasparente strip-strip.
Non interrompe il fascio di luce.
Compatibile con strip monocromatiche.
Supporta 6-24V, max 5A.

Transparent strip-strip connector
It does not interrupt the beam of light
Compatible with monochrome strips.
Supports 6-24V, max 5A.

J083/J103

Prolunghe ed elementi di connessione / Extensions and connection elements

IP20

Connections - Strip series



Codice prodotto Item code	Larghezza strip Strip width
J083	8mm
J103	10mm

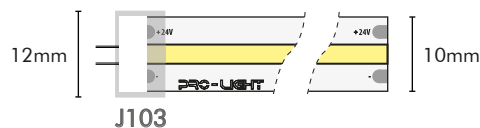

J083/J103 — Connections series

Connettore a pressione cavo-strip.
Compatibile con strip monocromatiche.
Non occorre spellare i cavi.
Supporta 6-24V, max 5A.

Cable-strip push connector.
Compatible with monochrome strips.
There is no need to strip the cables.
Supports 6-24V, max 5A.

J11

Prolunghe ed elementi di connessione / Extensions and connection elements

IP20

Connections - Strip series



Codice prodotto Item code	Compatibilità Compatibility
J11	Fino a/up to 2x0,75mm ²



J11 — Connections series

Connettore a pressione cavo-cavo.
Compatibile con cavi fino a 2x0,75mm².
Non occorre spellare i cavi.
Supporta 6-24V, max 5A.

Cable-cable push connector.
Compatible with cables up to 2x0,75mm².
There is no need to strip the cables.
Supports 6-24V, max 5A.

J14

Prolunghe ed elementi di connessione / Extensions and connection elements

IP20

Connections - Strip series



Codice prodotto Item code	Compatibilità Compatibility
J14	J11

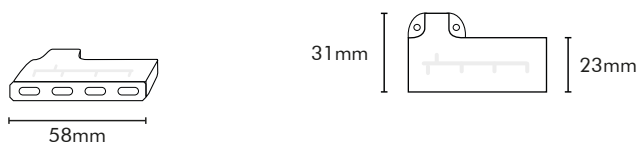

J14 — Connections series

Distributore di potenza da 1 a 4 vie, per connettere rapidamente fino a 4 cavi con connettore J11.
È necessario il connettore J11 sia in entrata che in uscita.
Supporta 6-24V, max 6A in collegamento complessivo.

Power distributor from 1 to 4 ways, to quickly connect up to 4 cables with J11 connector.
The J11 connector is required for both input and output.
Supports 6-24V, max 6A in overall connection.

J26

Prolunghe ed elementi di connessione / Extensions and connection elements

IP20

Connections - Strip series

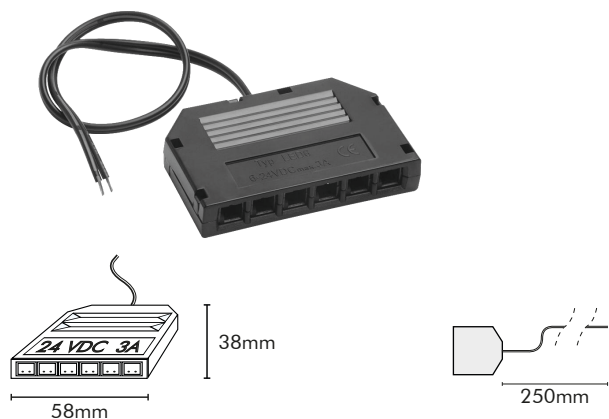

Codice prodotto Item code	Lunghezza cavo Cable length
J26	250mm

J26 — Connections - Strip series

Distributore di potenza da 1 a 6 vie, per connettere rapidamente fino a 6 elementi di illuminazione cablati con cavo J26C.

Power distributor from 1 to 6 ways, to quickly connect up to 6 lighting elements wired with J26C cable.

Supporta 6-24V, max 3A in collegamento complessivo.

Supports 6-24V, max 3A in overall connection.

J26C

Prolunghe ed elementi di connessione / Extensions and connection elements

IP20

Connections - Strip series



Codice prodotto Item code	Lunghezza cavo Cable length
J26C-100	100cm
J26C-200	200cm

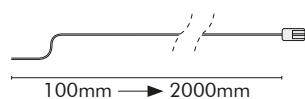

J26C — Connections series

Cavo utile per connettere dispositivi di illuminazione al distributore J26.

Cable useful for connecting lighting devices to the J26 distributor. One end with J26 compatible male connector.

Un' estremità con connettore maschio compatibile con J26.

One end with stripped cable, without connector.

Un' estremità con cavo spellato, senza connettore.

Length can be customized (max 2 meters).

La lunghezza può essere personalizzata (max 2 metri).

J26E

Prolunghe ed elementi di connessione / Extensions and connection elements

IP20

Connections - Strip series

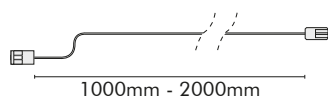

Codice prodotto Item code	Lunghezza cavo Cable length
J26E-100	100cm
J26E-200	200cm

J26E — Connections series

Cavo extender utile per allungare i cablaggi rapidamente e senza effettuare saldature.

Un' estremità con connettore maschio compatibile con J26.

Un' estremità con connettore femmina, compatibile con maschio.

Cable extender useful for extending wiring quickly and without soldering.

One end with J26 compatible male connector.

One end with female connector, compatible with male.

JPLE

Prolunghe ed elementi di connessione / Extensions and connection elements

IP20

Connections - Strip series

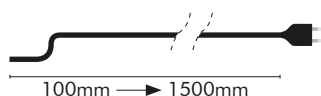

Codice prodotto Item code	Lunghezza cavo Cable length
JPLE-150	150cm

JPLE — Connections series

Cavo di alimentazione con spina bipolare ai terminali. La lunghezza può essere personalizzata.

Power cable with bipolar plug at the terminals. Length can be customized.

JCAR

Prolunghe ed elementi di connessione / Extensions and connection elements

IP20

Connections - Strip series

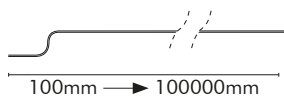

Codice prodotto Item code	Lunghezza cavo Cable length
JCAR-1	1m
JCAR-10	10m
JCAR-100	100m

JCA — Connections - Strip series

Cavo standard rosso e nero, tagliato a misura.
La lunghezza può essere personalizzata.
Bobina intera 100 metri.

Standard black and red cable, cut to size.
Length can be customized.
Whole reel 100 meters.

JCAT

Prolunghe ed elementi di connessione / Extensions and connection elements

IP20

Connections - Strip series

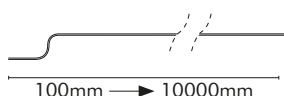

Codice prodotto Item code	Lunghezza cavo Cable length
JCAT-1	1m
JCAT-10	10m

JCAT — Connections - Strip series

Cavo standard trasparente, tagliato a misura.
La lunghezza può essere personalizzata.
Bobina intera 10 metri.

Standard transparent cable, cut to size.
Length can be customized.
Whole reel 10 meters.



Profile Series

Profili / Profiles

Superficie, incasso e sospensione / Surface, recessed and suspension

Profile series

Alu

Profilo in alluminio per strip led / Aluminium profile for led strips



WS1709

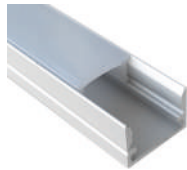

WS1208



WS1715



WS0908



WS1806



WS2310

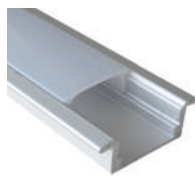

WI2309

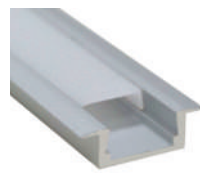

WI2207



WI2514

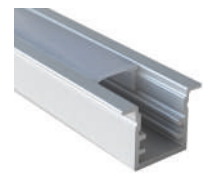

WI1510



WI2409

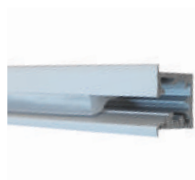

WI1210



WS1332



WI5213



WI6114



WI1501



WA1818



WA1616



WP4418

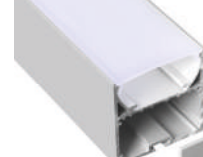

WP5050

Profile series

Superficie / Surface

Profili / Profiles

Profile series

XPS

Profilo in XPS / XPS profile



PA01



PA03



PA05



PA07



AN04



AN06

Myway

Prodotto finito realizzato su misura / Tailor made finished product

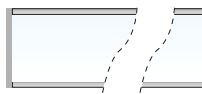

1709myway

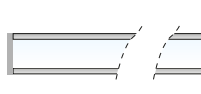

0908myway



2309myway

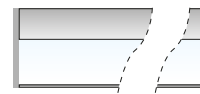

1818myway

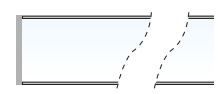

1616myway

WS1709

Superficie o incasso / Surface or recessed

Profilo in alluminio / Aluminium profile

Alu - Profile series



Finiture / Finishes

- Alluminio / Aluminium
- Nero / Black
- Bianco / White
- RAL (su richiesta) / RAL (upon request)

Codice prodotto Item code	Lunghezza Length	Finitura Finish
WS1709-200	200cm	●
WS1709-300	300cm	●
WS1709B-200	200cm	●
WS1709W-200	200cm	○

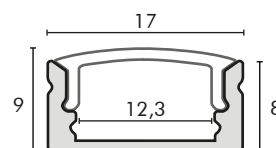

WS1709 — Alu - Profile series

Profilo in alluminio per installazione a superficie o incasso. Ideale per integrazione a vista o incasso su ripiano o pensile. Schermo in policarbonato ed accessori non inclusi (vedi lista schermo e accessori).

Aluminum profile for surface or recessed installation. Ideal for visible integration or built-in on a shelf or wall unit. Polycarbonate screen and accessories not included (see screen and accessories list).

Installazione

- Clips in metallo
- Nastro biadesivo
- Colla professionale
- Viti

Installation

- Metal clips
- Double sided tape
- Professional glue
- Screws

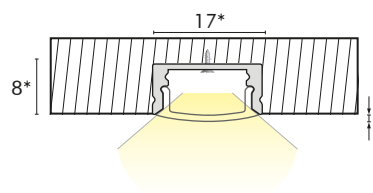
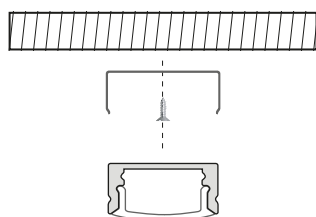
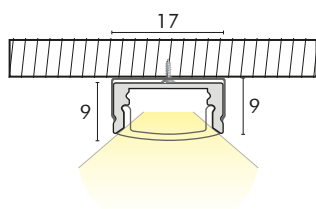

* Fresatura consigliata
*Recommended milling

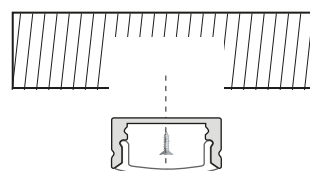

WS1709

Profilo in alluminio / Aluminium profile





Superficie o incasso / Surface or recessed

Alu - Profile series

Accessori / Accessories

Codice prodotto Item code	Finitura Finish	Descrizione Description
WS1709-T	●	Tappo in PC / PC end cap
WS1709-TF	●	Tappo in PC con foro / PC end cap with hole
WS1709B-T	●	Tappo in PC / PC end cap
WS1709B-TF	●	Tappo in PC con foro / PC end cap with hole
WS1709W-T	○	Tappo in PC / PC end cap
WS1709W-TF	○	Tappo in PC con foro / PC end cap with hole
WS1709-C	●	Clip in metallo / Metal clip

Schermo in policarbonato / Polycarbonate screen

<p>Trasparente - 95% Transparent - 95%</p>  <p>W01T (200cm) W03T (300cm)</p>	<p>Satinata latte - 60% Milky - 60%</p>  <p>W01S (200cm) W03S (300cm)</p>	<p>Semitrasparente - 80% Semitransparent - 80%</p>  <p>W01ST (200cm) W03ST (300cm)</p>	<p>Fumé - 60% Smoky - 60%</p>  <p>W01B (200cm)</p>
---	--	---	--

Accensioni / Ignitions

- Sensore Pir / Pir Sensor
- Sensore passaggio mano / Hand sweep sensor
- Interruttore touch con led / Touch switch with led
- Sensore IR da anta battente / IR sensor for hinged door

Strip led / Led strip

Compatibile con le strip led Pro-Light della serie: / Compatible with Pro-Light LED strips of the series:

- COB
- PLUS
- ULTRA
- OVER
- SPECIAL

WS1208

Superficie o incasso / Surface or recessed

Profilo in alluminio / Aluminium profile

Alu - Profile series



Finiture / Finishes

- Alluminio / Aluminium
- RAL (su richiesta) / RAL (upon request)

Codice prodotto Item code	Lunghezza Length	Finitura Finish
WS1208-200	200cm	●
WS1208-300	300cm	●

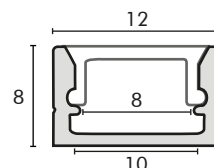

WS1208 — Alu - Profile series

Profilo in alluminio per installazione a superficie o incasso. Ideale per integrazione a vista o incasso su ripiano o pensile. Schermo in policarbonato ed accessori non inclusi (vedi lista schermo e accessori).

Aluminum profile for surface or recessed installation. Ideal for visible integration or built-in on a shelf or wall unit. Polycarbonate screen and accessories not included (see screen and accessories list).

Installazione

- Clips in metallo
- Nastro biadesivo
- Colla professionale
- Viti

Installation

- Metal clips
- Double sided tape
- Professional glue
- Screws

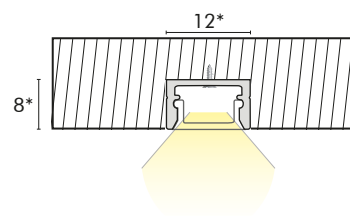
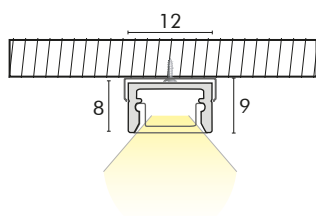

* Fresatura consigliata
*Recommended milling

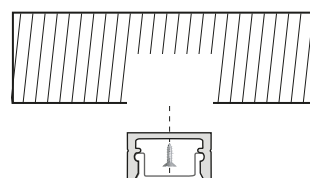
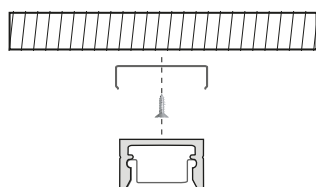

WS1208

Profilo in alluminio / Aluminium profile

Superficie o incasso / Surface or recessed

Alu - Profile series

Accessori / Accessories

Codice prodotto Item code	Finitura Finish	Descrizione Description
WS1208-T	●	Tappo in PC / PC end cap
WS1208-TF	●	Tappo in PC con foro / PC end cap with hole
WS1208-C	●	Clip in metallo / Metal clip

Schermo in policarbonato / Polycarbonate screen

<p>Trasparente - 95% Transparent - 95%</p>  <p>W02T (200cm) W04T (300cm)</p>	<p>Satinata latte - 60% Milky - 60%</p>  <p>W02S (200cm) W04S (300cm)</p>
--	---

Accensioni / Ignitions

- Sensore IR da anta battente / IR sensor for hinged door

Strip led / Led strip

Compatibile con le strip led Pro-Light della serie: / Compatible with Pro-Light LED strips of the series:

- COB
- PLUS
- ULTRA
- OVER
- SPECIAL

WS1715

Superficie o incasso / Surface or recessed

Profilo in alluminio / Aluminium profile

Alu - Profile series



Finiture / Finishes

- Alluminio / Aluminium
- RAL (su richiesta) / RAL (upon request)

Codice prodotto Item code	Lunghezza Length	Finitura Finish
WS1715-200	200cm	●
WS1715-300	300cm	●

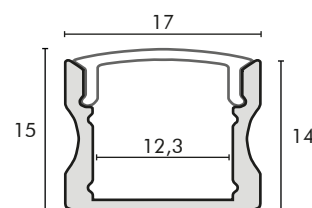

WS1715 — Alu - Profile series

Profilo in alluminio per installazione a superficie o incasso. Ideale per integrazione a vista o incasso su ripiano o pensile. Schermo in policarbonato ed accessori non inclusi (vedi lista schermo e accessori).

Aluminum profile for surface or recessed installation. Ideal for visible integration or built-in on a shelf or wall unit. Polycarbonate screen and accessories not included (see screen and accessories list).

Installazione

- Clips in metallo
- Nastro biadesivo
- Colla professionale
- Viti

Installation

- Metal clips
- Double sided tape
- Professional glue
- Screws

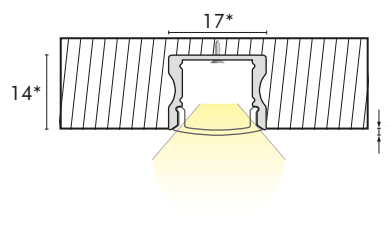
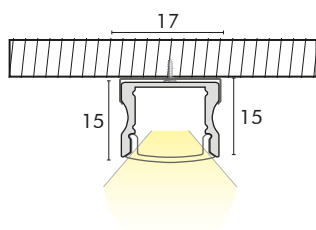

* Fresatura consigliata
*Recommended milling

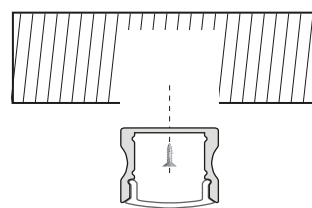
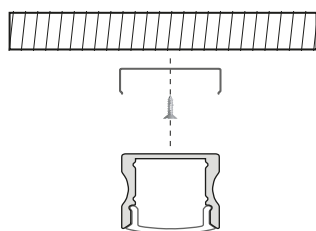

WS1715

Profilo in alluminio / Aluminium profile



Superficie o incasso / Surface or recessed

Alu - Profile series

Accessori / Accessories

Codice prodotto Item code	Finitura Finish	Descrizione Description
WS1715-T	●	Tappo in PC / PC end cap
WS1715-TF	●	Tappo in PC con foro / PC end cap with hole
WS1715-C	●	Clip in metallo / Metal clip

Schermo in policarbonato / Polycarbonate screen

<p>Trasparente - 95% Transparent - 95%</p>  <p>W01T (200cm) W03T (300cm)</p>	<p>Satinata latte - 60% Milky - 60%</p>  <p>W01S (200cm) W03S (300cm)</p>	<p>Semitrasparente - 80% Semitransparent - 80%</p>  <p>W01ST (200cm) W03ST (300cm)</p>	<p>Fumé - 60% Smoky - 60%</p>  <p>W01B (200cm)</p>
--	---	--	---

Accensioni / Ignitions

- Sensore Pir / Pir Sensor
- Sensore passaggio mano / Hand sweep sensor
- Interruttore touch con led / Touch switch with led
- Sensore IR da anta battente / IR sensor for hinged door

Strip led / Led strip

Compatibile con le strip led Pro-Light della serie: / Compatible with Pro-Light LED strips of the series:

- COB
- PLUS
- ULTRA
- OVER
- SPECIAL

WS0908

Superficie o incasso / Surface or recessed

Profilo in alluminio / Aluminium profile

Alu - Profile series

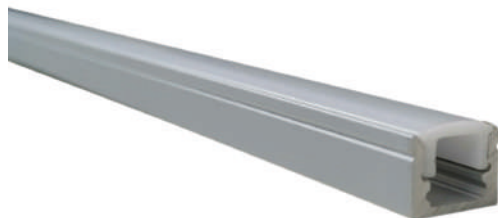

Finiture / Finishes

- Alluminio / Aluminium
- RAL (su richiesta) / RAL (upon request)

Codice prodotto Item code	Lunghezza Length	Finitura Finish
WS0908-200S	200cm	●
WS0908-300S	300cm	●

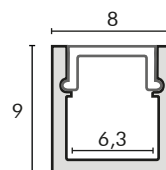

WS0908 — Alu - Profile series

Profilo in alluminio per installazione a superficie o incasso. Ideale per integrazione a vista o incasso su ripiano o pensile. Schermo in policarbonato satinato incluso. Accessori non inclusi (vedi lista accessori).

Aluminum profile for surface or recessed installation. Ideal for visible integration or built-in on a shelf or wall unit. Satin polycarbonate screen included. Accessories not included (see accessories list).

Installazione

- Clips in metallo
- Nastro biadesivo
- Colla professionale
- Viti

Installation

- Metal clips
- Double sided tape
- Professional glue
- Screws

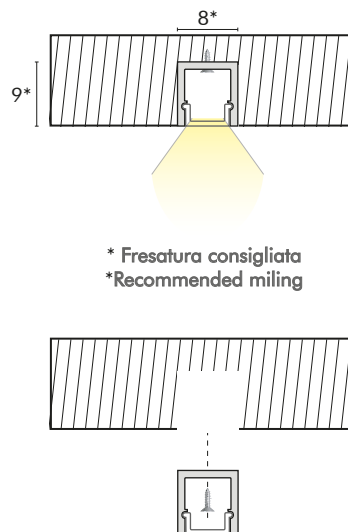
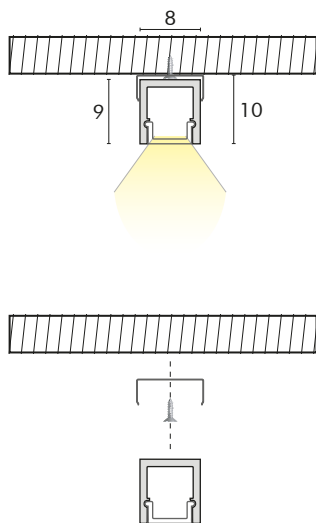

WS0908

Profilo in alluminio / Aluminium profile

Superficie o incasso / Surface or recessed

Alu - Profile series

Accessori / Accessories

Codice prodotto Item code	Finitura Finish	Descrizione Description
WS0908-T	●	Tappo in PC / PC end cap
WS0908-TF	●	Tappo in PC con foro / PC end cap with hole
WS0908-C	●	Clip in metallo / Metal clip

Accensioni / Ignitions

- Sensore IR da anta battente / IR sensor for hinged door

Strip led / Led strip

Compatibile con le strip led Pro-Light della serie: / Compatible with Pro-Light LED strips of the series:

- SPECIAL - NARROW

WS1806

Superficie / Surface

Profilo in alluminio / Aluminium profile

Alu - Profile series



Finiture / Finishes

- Alluminio / Aluminium
- RAL (su richiesta) / RAL (upon request)

Codice prodotto Item code	Lunghezza Length	Finitura Finish
WS1806-200S	200cm	●
WS1806-300S	300cm	●

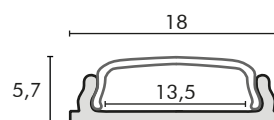

WS1806 — Alu - Profile series

Profilo in alluminio flessibile per installazione a superficie. Ideale per integrazione in mobili o specchiere dalla forma irregolare.

Schermo in policarbonato satinato incluso. Accessori non inclusi (vedi lista accessori).

Flexible aluminum profile for surface installation. Ideal for integration into irregularly shaped furniture or mirrors. Satin polycarbonate screen included. Accessories not included (see accessories list).

Installazione

- Clips in metallo
- Nastro biadesivo
- Colla professionale
- Viti

Installation

- Metal clips
- Double sided tape
- Professional glue
- Screws

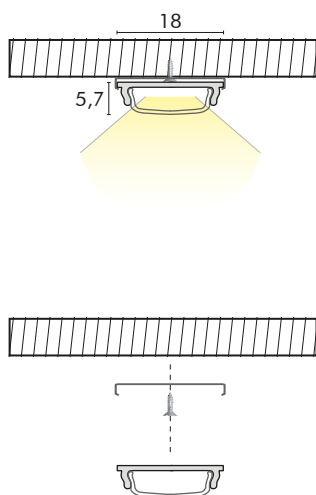

Alluminio flessibile
Bendable aluminum

WS1806

Profilo in alluminio / Aluminium profile

Superficie / Surface

Alu - Profile series

Accessori / Accessories

Codice prodotto Item code	Finitura Finish	Descrizione Description
WS1806-T	●	Tappo in PC / PC end cap
WS1806-TF	●	Tappo in PC con foro / PC end cap with hole
WS1806-C	●	Clip in metallo / Metal clip

Accensioni / Ignitions

- Sensore IR da anta battente / IR sensor for hinged door

Strip led / Led strip

Compatibile con le strip led Pro-Light della serie: / Compatible with Pro-Light LED strips of the series:

- COB
- PLUS
- ULTRA
- OVER
- SPECIAL

WS2310

Superficie / Surface

Profilo in alluminio / Aluminium profile

Alu - Profile series



Finiture / Finishes

- Alluminio / Aluminium
- RAL (su richiesta) / RAL (upon request)

Codice prodotto Item code	Lunghezza Length	Finitura Finish
WS2310-200S	200cm	●

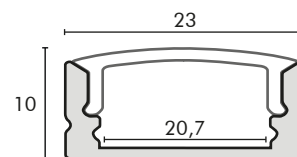

WS2310 — Alu - Profile series

Profilo in alluminio per installazione a superficie o incasso. Ideale per integrazione a vista o incasso su ripiano o pensile. Schermo in policarbonato satinato incluso. Accessori non inclusi (vedi lista accessori).

Aluminum profile for surface or recessed installation. Ideal for visible integration or built-in on a shelf or wall unit. Satin polycarbonate screen included. Accessories not included (see accessories list).

Installazione

- Clips in metallo
- Nastro biadesivo
- Colla professionale
- Viti

Installation

- Metal clips
- Double sided tape
- Professional glue
- Screws

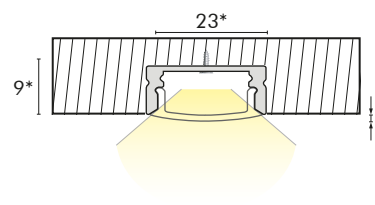
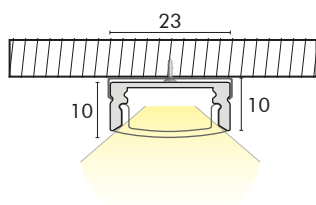

* Fresatura consigliata
* Recommended milling

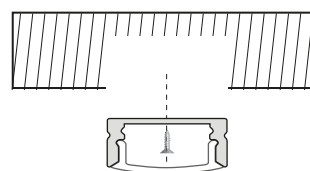
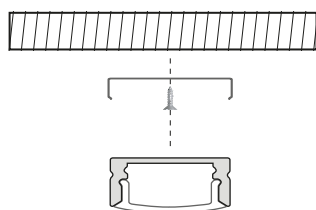

WS2310

Profilo in alluminio / Aluminium profile

Superficie / Surface

Alu - Profile series

Accessori / Accessories

Codice prodotto Item code	Finitura Finish	Descrizione Description
WS2310-T	●	Tappo in PC / PC end cap
WS2310-TF	●	Tappo in PC con foro / PC end cap with hole
WS2310-C	●	Clip in metallo / Metal clip

Accensioni / Ignitions

- Sensore Pir / Pir Sensor
- Sensore passaggio mano / Hand sweep sensor
- Interruttore touch con led / Touch switch with led
- Sensore IR da anta battente / IR sensor for hinged door

Strip led / Led strip

Compatibile con le strip led Pro-Light della serie: / Compatible with Pro-Light LED strips of the series:

- COB
- PLUS
- ULTRA
- OVER
- SPECIAL

WI2309

Incasso / Recessed

Profilo in alluminio / Aluminium profile

Alu - Profile series



Finiture / Finishes

- Alluminio / Aluminium
- RAL (su richiesta) / RAL (upon request)

Codice prodotto Item code	Lunghezza Length	Finitura Finish
WI2309-200	200cm	●
WI2309-300	300cm	●

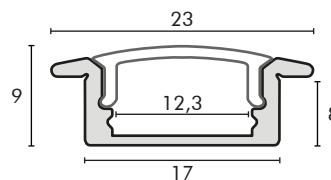

WI2309 — Alu - Profile series

Profilo in alluminio per installazione a incasso.
Ideale per integrazione a incasso su ripiano o pensile.
Schermo in policarbonato ed accessori non inclusi (vedi lista schermo e accessori).

Aluminum profile for recessed installation.
Ideal for recessed integration on shelf or wall unit.
Polycarbonate screen and accessories not included (see screen and accessories list).

Installazione

- Nastro biadesivo
- Colla professionale
- Viti

Installation

- Double sided tape
- Professional glue
- Screws

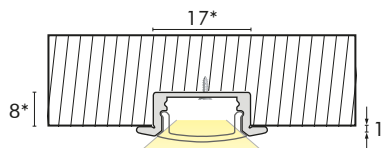

* Fresatura consigliata
*Recommended miling

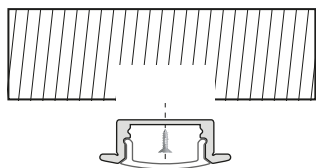

WI2309

Profilo in alluminio / Aluminium profile





Incasso / Recessed

Alu - Profile series

Accessori / Accessories

Codice prodotto Item code	Finitura Finish	Descrizione Description
WI2309-T	●	Tappo in PC / PC end cap
WI2309-TF	●	Tappo in PC con foro / PC end cap with hole

Schermo in policarbonato / Polycarbonate screen

<p>Trasparente - 95% Transparent - 95%</p>  <p>W01T (200cm) W03T (300cm)</p>	<p>Satinata latte - 60% Milky - 60%</p>  <p>W01S (200cm) W03S (300cm)</p>	<p>Semitrasparente - 80% Semitransparent - 80%</p>  <p>W01ST (200cm) W03ST (300cm)</p>	<p>Fumé - 60% Smoky - 60%</p>  <p>W01B (200cm)</p>
--	---	--	---

Accensioni / Ignitions

- Sensore Pir / Pir Sensor
- Sensore passaggio mano / Hand sweep sensor
- Interruttore touch con led / Touch switch with led
- Sensore IR da anta battente / IR sensor for hinged door

Strip led / Led strip

Compatibile con le strip led Pro-Light della serie: / Compatible with Pro-Light LED strips of the series:

- COB
- PLUS
- ULTRA
- OVER
- SPECIAL

WI2207

Incasso / Recessed

Profilo in alluminio / Aluminium profile

Alu - Profile series



Finiture / Finishes

- Alluminio / Aluminium
- RAL (su richiesta) / RAL (upon request)

Codice prodotto Item code	Lunghezza Length	Finitura Finish
WI2207-200	200cm	●
WI2207-300	300cm	●

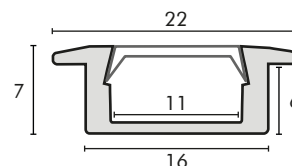

WI2207 — Alu - Profile series

Profilo in alluminio per installazione a incasso.
Ideale per integrazione a incasso su ripiano o pensile.
Schermo in policarbonato incluso.
Accessori non inclusi (vedi lista accessori).

Aluminum profile for recessed installation.
Ideal for recessed integration on shelf or wall unit.
Satin polycarbonate screen included.
Accessories not included (see accessories list).

Installazione

- Nastro biadesivo
- Colla professionale
- Viti

Installation

- Double sided tape
- Professional glue
- Screws

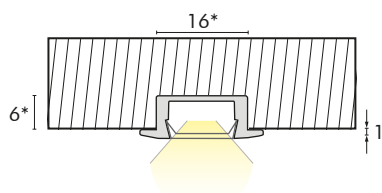

* Fresatura consigliata
*Recommended miling

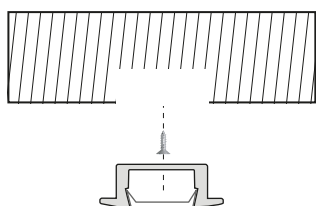

WI2207

Profilo in alluminio / Aluminium profile

Incasso / Recessed

Alu - Profile series

Accessori / Accessories

Codice prodotto Item code	Finitura Finish	Descrizione Description
WI2207-T	●	Tappo in PC / PC end cap
WI2207-TF	●	Tappo in PC con foro / PC end cap with hole

Accensioni / Ignitions

- Sensore Pir / Pir Sensor
- Sensore passaggio mano / Hand sweep sensor
- Interruttore touch con led / Touch switch with led
- Sensore IR da anta battente / IR sensor for hinged door

Strip led / Led strip

Compatibile con le strip led Pro-Light della serie: / Compatible with Pro-Light LED strips of the series:

- COB
- PLUS
- ULTRA
- OVER
- SPECIAL

WI2415

Incasso / Recessed

Profilo in alluminio / Aluminium profile

Alu - Profile series

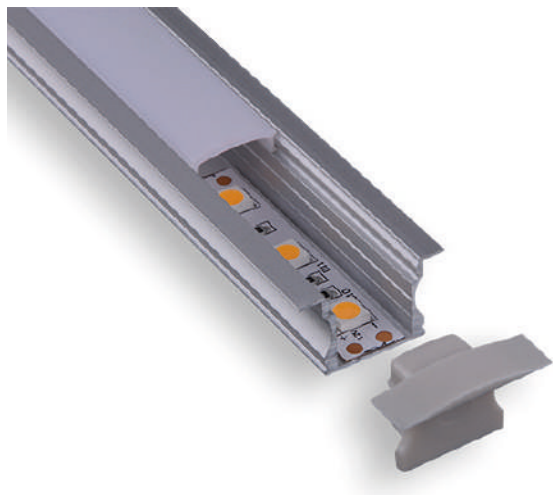

Finiture / Finishes

- Alluminio / Aluminium
- RAL (su richiesta) / RAL (upon request)

Codice prodotto Item code	Lunghezza Length	Finitura Finish
WI2415-200	200cm	●

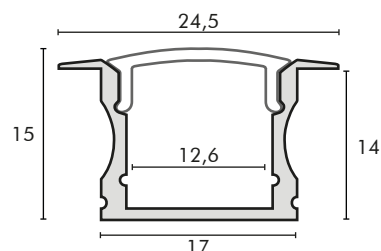

WI2415 — Alu - Profile series

Profilo in alluminio per installazione a incasso.
Ideale per integrazione a incasso su ripiano o pensile.
Schermo in policarbonato ed accessori non inclusi (vedi lista schermo e accessori).

Aluminum profile for recessed installation.
Ideal for recessed integration on shelf or wall unit.
Polycarbonate screen and accessories not included (see screen and accessories list).

Installazione

- Nastro biadesivo
- Colla professionale
- Viti

Installation

- Double sided tape
- Professional glue
- Screws

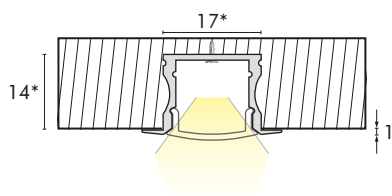

* Fresatura consigliata
*Recommended milling

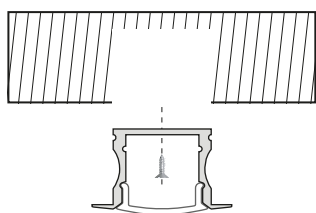

WI2415

Profilo in alluminio / Aluminium profile





Incasso / Recessed

Alu - Profile series

Accessori / Accessories

Codice prodotto Item code	Finitura Finish	Descrizione Description
WI2415-T	●	Tappo in PC / PC end cap
WI2415-TF	●	Tappo in PC con foro / PC end cap with hole

Schermo in policarbonato / Polycarbonate screen

<p>Trasparente - 95% Transparent - 95%</p>  <p>W01T (200cm) W03T (300cm)</p>	<p>Satinata latte - 60% Milky - 60%</p>  <p>W01S (200cm) W03S (300cm)</p>	<p>Semitrasparente - 80% Semitransparent - 80%</p>  <p>W01ST (200cm) W03ST (300cm)</p>	<p>Fumé - 60% Smoky - 60%</p>  <p>W01B (200cm)</p>
--	---	--	---

Accensioni / Ignitions

- Sensore Pir / Pir Sensor
- Sensore passaggio mano / Hand sweep sensor
- Interruttore touch con led / Touch switch with led
- Sensore IR da anta battente / IR sensor for hinged door

Strip led / Led strip

Compatibile con le strip led Pro-Light della serie: / Compatible with Pro-Light LED strips of the series:

- COB
- PLUS
- ULTRA
- OVER
- SPECIAL

WI1510

Incasso / Recessed

Profilo in alluminio / Aluminium profile

Alu - Profile series



Finiture / Finishes

- Alluminio / Aluminium
- RAL (su richiesta) / RAL (upon request)

Codice prodotto Item code	Lunghezza Length	Finitura Finish
WI1510-200	200cm	●
WI1510-300	300cm	●

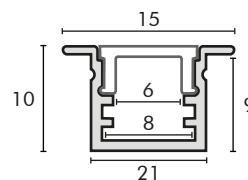

WI1510 — Alu - Profile series

Profilo in alluminio per installazione a incasso.
Ideale per integrazione a incasso su ripiano o pensile.
Schermo in policarbonato incluso.
Accessori non inclusi (vedi lista accessori).

Aluminum profile for recessed installation.
Ideal for recessed integration on shelf or wall unit.
Satin polycarbonate screen included.
Accessories not included (see accessories list).

Installazione

- Nastro biadesivo
- Colla professionale
- Viti

Installation

- Double sided tape
- Professional glue
- Screws

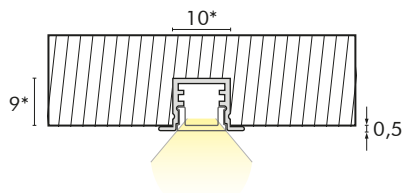

* Fresatura consigliata
*Recommended miling

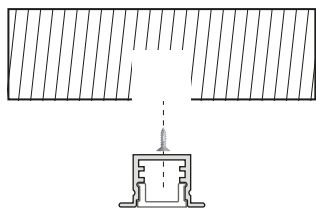

W11510

Profilo in alluminio / Aluminium profile

Incasso / Recessed

Alu - Profile series

Accessori / Accessories

Codice prodotto Item code	Finitura Finish	Descrizione Description
W11510-T	●	Tappo in PC / PC end cap
W11510-TF	●	Tappo in PC con foro / PC end cap with hole

Accensioni / Ignitions

- Sensore IR da anta battente / IR sensor for hinged door

Strip led / Led strip

Compatibile con le strip led Pro-Light della serie: / Compatible with Pro-Light LED strips of the series:

- SPECIAL - NARROW

WI2409

Incasso / Recessed

Profilo in alluminio / Aluminium profile

Alu - Profile series



Finiture / Finishes

- Alluminio / Aluminium
- RAL (su richiesta) / RAL (upon request)

Codice prodotto Item code	Lunghezza Length	Finitura Finish
WI2409-300	300cm	●

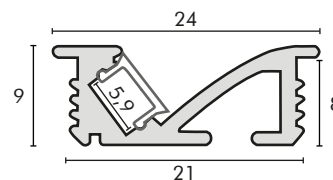

WI2409 — Alu - Profile series

Profilo in alluminio per installazione a incasso.
Ideale per integrazione a incasso su ripiano o pensile.
Schermo in policarbonato incluso.
Accessori non inclusi (vedi lista accessori).

Aluminum profile for recessed installation.
Ideal for recessed integration on shelf or wall unit.
Satin polycarbonate screen included.
Accessories not included (see accessories list).

Installazione

- Clips in metallo
- Nastro biadesivo
- Colla professionale

Installation

- Metal Clips
- Double sided tape
- Professional glue

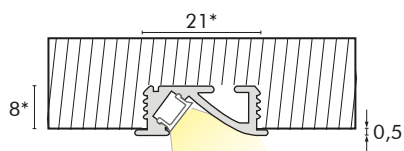

* Fresatura consigliata
*Recommended milling

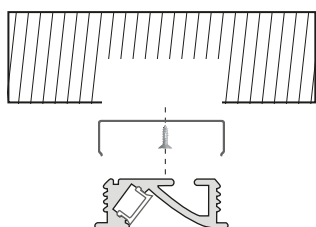

W12409

Profilo in alluminio / Aluminium profile

Incasso / Recessed

Alu - Profile series

Accessori / Accessories

Codice prodotto Item code	Finitura Finish	Descrizione Description
W12409-T	●	Tappo in PC / PC end cap
W12409-TF	●	Tappo in PC con foro / PC end cap with hole
W12409-C	●	Clip in metallo / Metal clip

Accensioni / Ignitions

- Sensore IR da anta battente / IR sensor for hinged door

Strip led / Led strip

Compatibile con le strip led Pro-Light della serie: / Compatible with Pro-Light LED strips of the series:

- SPECIAL - NARROW

WI1210

Incasso / Recessed

Profilo in alluminio / Aluminium profile

Alu - Profile series



Finiture / Finishes

- Alluminio / Aluminium
- RAL (su richiesta) / RAL (upon request)

Codice prodotto Item code	Lunghezza Length	Finitura Finish
WI1210-300	300cm	●

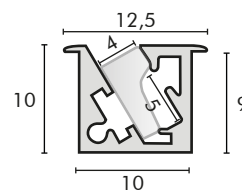

WI1210 — Alu - Profile series

Profilo in alluminio per installazione a incasso.
Ideale per integrazione a incasso su ripiano o pensile.
Schermo in silicone incluso.
Accessori non inclusi (vedi lista accessori).

Aluminum profile for recessed installation.
Ideal for recessed integration on shelf or wall unit.
Satin silicon screen included.
Accessories not included (see accessories list).

Installazione

- Nastro biadesivo
- Colla professionale

Installation

- Double sided tape
- Professional glue

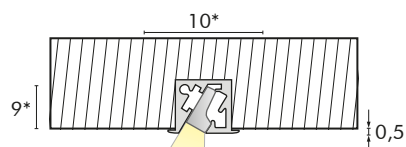

* Fresatura consigliata
*Recommended milling

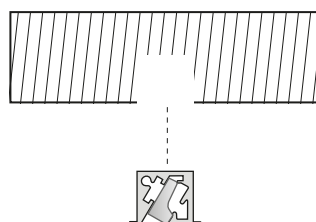

W11210

Profilo in alluminio / Aluminium profile

Incasso / Recessed

Alu - Profile series

Accessori / Accessories

Codice prodotto Item code	Finitura Finish	Descrizione Description
W11210-T	●	Tappo in PC / PC end cap
W11210-TF	●	Tappo in PC con foro / PC end cap with hole

Accensioni / Ignitions

- Sensore IR da anta battente / IR sensor for hinged door

Strip led / Led strip

Compatibile con le strip led Pro-Light della serie: / Compatible with Pro-Light LED strips of the series:

- SPECIAL - NARROW

WS1332

Incasso / Recessed

Profilo in alluminio / Aluminium profile

Alu - Profile series

Finiture / Finishes

- Alluminio / Aluminium



Codice prodotto Item code	Lunghezza Length	Finitura Finish
WS1332-200S	200cm	●

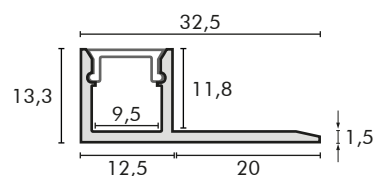

WS1332 —● Alu - Profile series

Profilo in alluminio per installazione a incasso.
Ideale per integrazione su pannello in cartongesso.
Schermo in policarbonato incluso.
Accessori non inclusi (vedi lista accessori).

Aluminum profile for recessed installation.
Ideal for integration on plasterboard panel.
Satin polycarbonate screen included.
Accessories not included (see accessories list).

Installazione

- Viti

Installation

- Screws

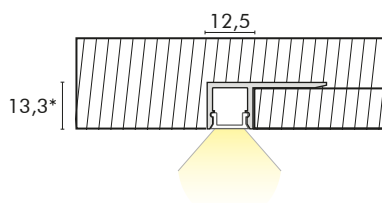

* Fresatura consigliata
*Recommended milling

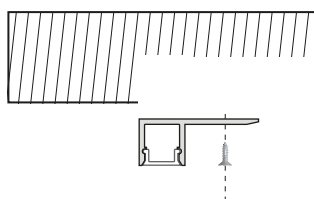

WS1332

Profilo in alluminio / Aluminium profile

Incasso / Recessed

Alu - Profile series

Accessori / Accessories

Codice prodotto Item code	Finitura Finish	Descrizione Description
WS1332-T	●	Tappo in PC / PC end cap
WS1332-TF	●	Tappo in PC con foro / PC end cap with hole

Accensioni / Ignitions

- Sensore IR da anta battente / IR sensor for hinged door

Strip led / Led strip

Compatibile con le strip led Pro-Light della serie: / Compatible with Pro-Light LED strips of the series:

- COB
- PLUS
- OVER
- SPECIAL

WI5213

Incasso / Recessed

Profilo in alluminio / Aluminium profile

Alu - Profile series



Finiture / Finishes

- Alluminio / Aluminium

Codice prodotto Item code	Lunghezza Length	Finitura Finish
WI5213-200S	200cm	●

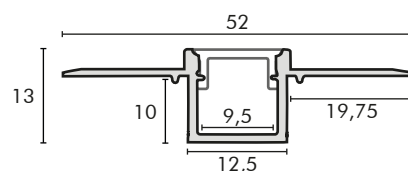

WI5213 — Alu - Profile series

Profilo in alluminio per installazione a incasso.
Ideale per integrazione su pannello in cartongesso.
Schermo in policarbonato incluso.
Accessori non inclusi (vedi lista accessori).

Aluminum profile for recessed installation.
Ideal for integration on plasterboard panel.
Satin polycarbonate screen included.
Accessories not included (see accessories list).

Installazione

- Viti

Installation

- Screws

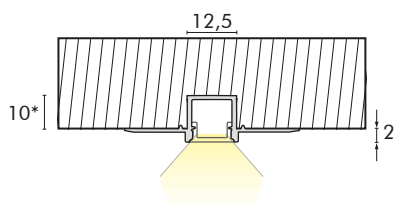

* Fresatura consigliata
*Recommended miling

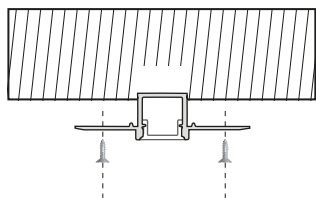

WI5213

Profilo in alluminio / Aluminium profile

Incasso / Recessed

Alu - Profile series

Accessori / Accessories

Codice prodotto Item code	Finitura Finish	Descrizione Description
WI5213-T	●	Tappo in PC / PC end cap
WI5213-TF	●	Tappo in PC con foro / PC end cap with hole

Accensioni / Ignitions

- Interruttore touch con led / Touch switch with led

Strip led / Led strip

Compatibile con le strip led Pro-Light della serie: / Compatible with Pro-Light LED strips of the series:

- COB
- PLUS
- OVER
- SPECIAL

WI6114

Incasso / Recessed

Profilo in alluminio / Aluminium profile

Alu - Profile series

Finiture / Finishes

- Alluminio / Aluminium



Codice prodotto Item code	Lunghezza Length	Finitura Finish
WI6114-200S	200cm	●

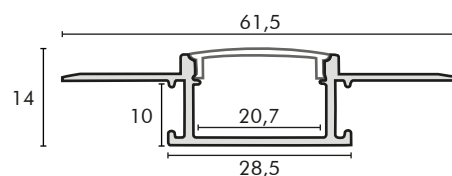

WI6114 — Alu - Profile series

Profilo in alluminio per installazione a incasso.
Ideale per integrazione su pannello in cartongesso.
Schermo in policarbonato incluso.
Accessori non inclusi (vedi lista accessori).

Aluminum profile for recessed installation.
Ideal for integration on plasterboard panel.
Satin polycarbonate screen included.
Accessories not included (see accessories list).

Installazione

- Viti

Installation

- Screws

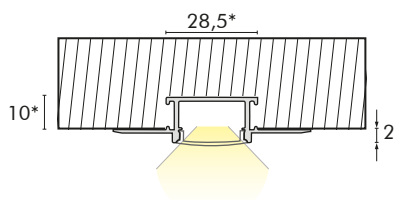

* Fresatura consigliata
*Recommended milling

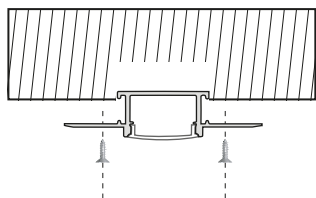

WI6114

Profilo in alluminio / Aluminium profile

Incasso / Recessed

Alu - Profile series

Accessori / Accessories

Codice prodotto Item code	Finitura Finish	Descrizione Description
WI6114-T	●	Tappo in PC / PC end cap
WI6114-TF	●	Tappo in PC con foro / PC end cap with hole

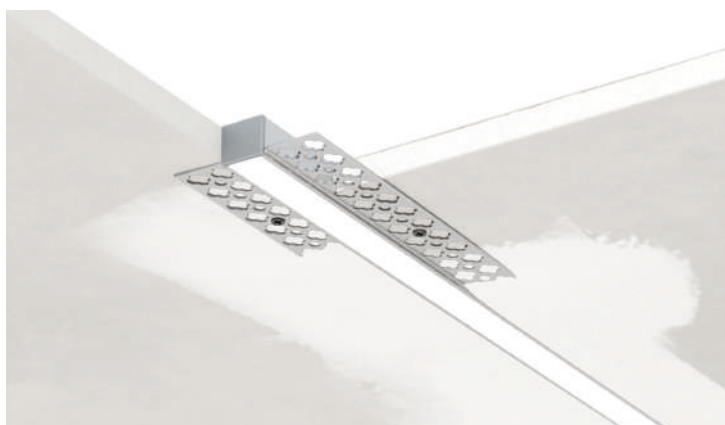

Strip led / Led strip

Compatibile con le strip led Pro-Light della serie: / Compatible with Pro-Light LED strips of the series:

- COB
- PLUS
- ULTRA
- OVER
- SPECIAL

W11501

Incasso / Recessed

Profilo in alluminio / Aluminium profile

Alu - Profile series

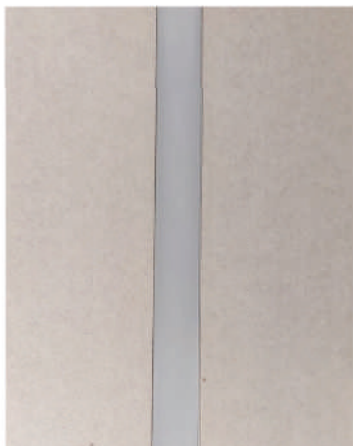

Finiture / Finishes

- Alluminio / Aluminium

Codice prodotto Item code	Lunghezza Length	Finitura Finish
W11501-200S	200cm	●

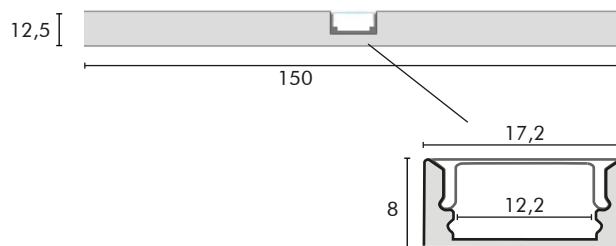

W11501 — Alu - Profile series

Lastra di cartongesso con profilo in alluminio inserito all' interno.

Plasterboard sheet with aluminum profile inside.

Fornito con guaina da inserire nel profilo e rimuovere in seguito alla stuccatura, rendendo questa fase facile e veloce. Diffusore in policarbonato satinato compreso.

Supplied with a sheath to insert inside the profile and remove after grouting, making this phase quick and easy. Satin polycarbonate diffuser included.

Installazione

Installation

- Fissaggio del cartongesso con chiodi o viti

- Plasterboard fixing with nails or screws

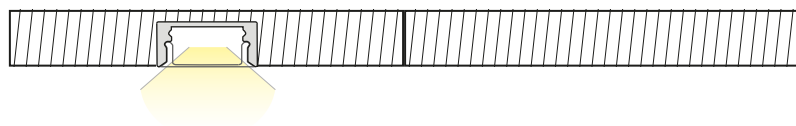

W11501

Profilo in alluminio / Aluminium profile

Incasso / Recessed

Alu - Profile series

Accessori / Accessories

Codice prodotto Item code	Finitura Finish	Descrizione Description
W11501-L	●	Elemento di connessione a "L" / "L" shaped connection element
W11501-T	●	Elemento di connessione a "T" / "T" shaped connection element
W11501-X	●	Elemento di connessione a "+" / "+" shaped connection element

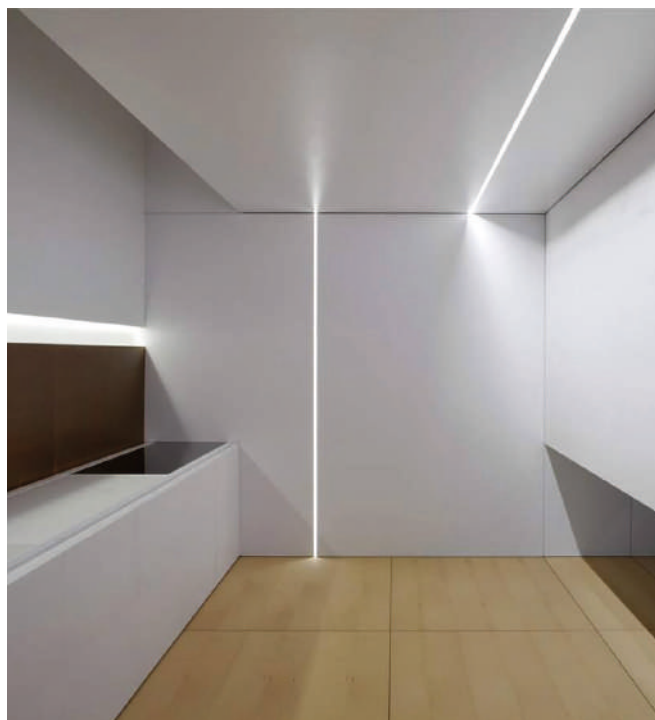

Strip led / Led strip

Compatibile con le strip led Pro-Light della serie: / Compatible with Pro-Light LED strips of the series:

- COB
- PLUS
- ULTRA
- OVER
- SPECIAL

WA1818

Angolare / Angular

Profilo in alluminio / Aluminium profile

Alu - Profile series



Finiture / Finishes

- Alluminio / Aluminium
- RAL (su richiesta) / RAL (upon request)

Codice prodotto Item code	Lunghezza Length	Finitura Finish
WA1818-200	200cm	●
WA1818-300	300cm	●

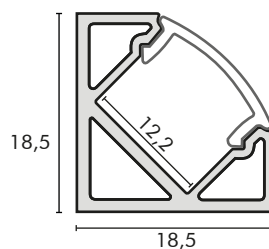

WA1818 — Alu - Profile series

Profilo in alluminio per installazione a superficie.
Ideale per integrazione angolare su ripiano o pensile.
Schermo in policarbonato ed accessori non inclusi (vedi lista schermo e accessori).

Aluminum profile for surface installation.
Ideal for corner integration on shelf or wall unit.
Polycarbonate screen and accessories not included (see screen and accessories list).

Installazione

- Clips in metallo
- Nastro biadesivo
- Colla professionale

Installation

- Metal clips
- Double sided tape
- Professional glue

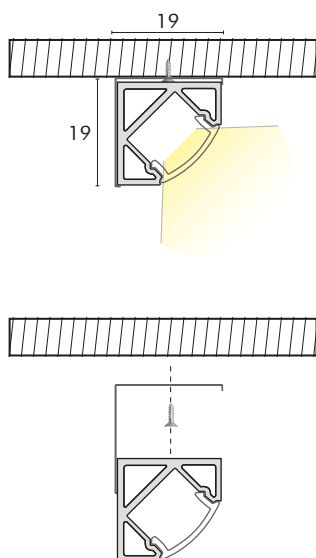

WA1818

Profilo in alluminio / Aluminium profile



Angolare / Angular

Alu - Profile series

Accessori / Accessories

Codice prodotto Item code	Finitura Finish	Descrizione Description
WA1818-T	●	Tappo in PC / PC end cap
WA1818-TF	●	Tappo in PC con foro / PC end cap with hole
WA1818-C	●	Clip in metallo / Metal clip

Schermo in policarbonato / Polycarbonate screen

<p>Trasparente - 95% Transparent - 95%</p>  <p>W01T (200cm) W03T (300cm)</p>	<p>Satinata latte - 60% Milky - 60%</p>  <p>W01S (200cm) W03S (300cm)</p>	<p>Semitrasparente - 80% Semitransparent - 80%</p>  <p>W01ST (200cm) W03ST (300cm)</p>	<p>Fumé - 60% Smoky - 60%</p>  <p>W01B (200cm)</p>
--	---	--	---

Accensioni / Ignitions

- Sensore Pir / Pir Sensor
- Sensore passaggio mano / Hand sweep sensor
- Interruttore touch con led / Touch switch with led
- Sensore IR da anta battente / IR sensor for hinged door

Strip led / Led strip

Compatibile con le strip led Pro-Light della serie: / Compatible with Pro-Light LED strips of the series:

- COB
- PLUS
- ULTRA
- OVER
- SPECIAL

WA1616

Angolare / Angular

Profilo in alluminio / Aluminium profile

Alu - Profile series



Finiture / Finishes

- Alluminio / Aluminium
- RAL (su richiesta) / RAL (upon request)

Codice prodotto Item code	Lunghezza Length	Finitura Finish
WA1616-200S	200cm	●
WA1616-300S	300cm	●

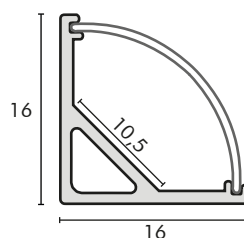

WA1616 — Alu - Profile series

Profilo in alluminio per installazione a superficie.
Ideale per integrazione angolare su ripiano o pensile.
Schermo in policarbonato satinato incluso.
Accessori non inclusi (vedi lista accessori).

Aluminum profile for surface installation.
Ideal for corner integration on shelf or wall unit.
Satin polycarbonate screen included.
Accessories not included (see accessories list).

Installazione

- Clips in metallo
- Nastro biadesivo
- Colla professionale

Installation

- Metal clips
- Double sided tape
- Professional glue

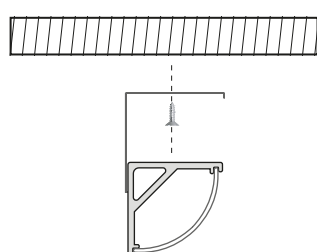
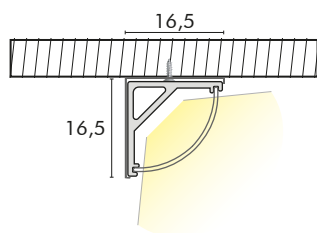

WA1616

Profilo in alluminio / Aluminium profile

Angolare / Angular

Alu - Profile series

Accessori / Accessories

Codice prodotto Item code	Finitura Finish	Descrizione Description
WA1616-T	●	Tappo in PC / PC end cap
WA1616-TF	●	Tappo in PC con foro / PC end cap with hole
WA1616-C	●	Clip in metallo / Metal clip

Accensioni / Ignitions

- Sensore Pir / Pir Sensor
- Sensore passaggio mano / Hand sweep sensor
- Interruttore touch con led / Touch switch with led
- Sensore IR da anta battente / IR sensor for hinged door

Strip led / Led strip

Compatibile con le strip led Pro-Light della serie: / Compatible with Pro-Light LED strips of the series:

- COB
- PLUS
- ULTRA
- OVER
- SPECIAL

WP4418

Superficie / Surface

Profilo in alluminio / Aluminium profile

Alu - Profile series

Finiture / Finishes

- Bianco / White
- RAL (su richiesta) / RAL (upon request)



Codice prodotto Item code	Lunghezza Length	Finitura Finish
WP4418-200S	200cm	<input type="radio"/>

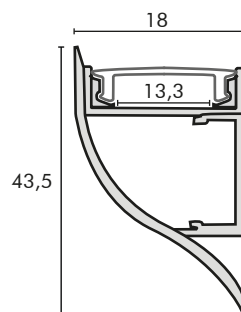

WP4418 — Alu - Profile series

Profilo in alluminio per installazione a parete.
Ideale per la creazione di velette luminose.
Schermo in policarbonato satinato incluso.
Accessori non inclusi (vedi lista accessori).

Aluminum profile for surface or recessed installation.
Ideal for creating luminous veils.
Satin polycarbonate screen included.
Accessories not included (see accessories list).

Installazione

- Clips in metallo

Installation

- Metal clips

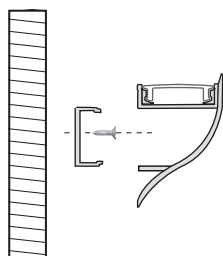
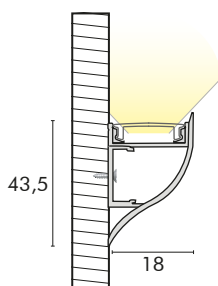

WP4418

Profilo in alluminio / Aluminium profile

Superficie / Surface

Alu - Profile series

Accessori / Accessories

Codice prodotto Item code	Finitura Finish	Descrizione Description
WP4418-T	○	Tappo in metallo / Metal end cap
WP4418-TF	○	Tappo in metallo con foro / Metal end cap with hole
WP4418-C	●	Clip in metallo / Metal clip

Accensioni / Ignitions

- Sensore Pir / Pir Sensor
- Sensore passaggio mano / Hand sweep sensor

Strip led / Led strip

Compatibile con le strip led Pro-Light della serie: / Compatible with Pro-Light LED strips of the series:

- COB
- PLUS
- ULTRA
- OVER
- SPECIAL

WP5050

Superficie / Surface

Profilo in alluminio / Aluminium profile

Alu - Profile series



Finiture / Finishes

- Alluminio / Aluminium
- RAL (su richiesta) / RAL (upon request)

Codice prodotto Item code	Lunghezza Length	Finitura Finish
WP5050-200	200cm	●

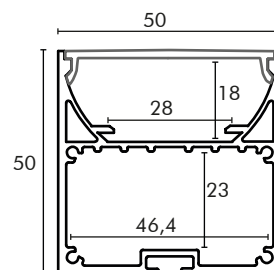

WP5050 — Alu - Profile series

Profilo in alluminio per installazione a sospensione. Ideale per la creazione di luci lineari. Schermo in policarbonato ed accessori non inclusi (vedi lista schermo e accessori).

Aluminum profile for suspension installation. Ideal for creating linear lighting. Polycarbonate screen and accessories not included (see screen and accessories list).

Installazione

- A sospensione

Installation

- Suspension

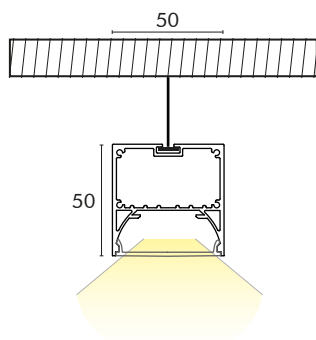

WP5050

Profilo in alluminio / Aluminium profile

Superficie / Surface

Alu - Profile series

Accessori / Accessories

Codice prodotto Item code	Finitura Finish	Descrizione Description
WP5050-T	●	Tappo in metallo / Metal end cap
WP5050-TF	●	Tappo in metallo con foro / Metal end cap with hole
WK01	●	Clip in metallo / Metal clip

Schermo in policarbonato / Polycarbonate screen

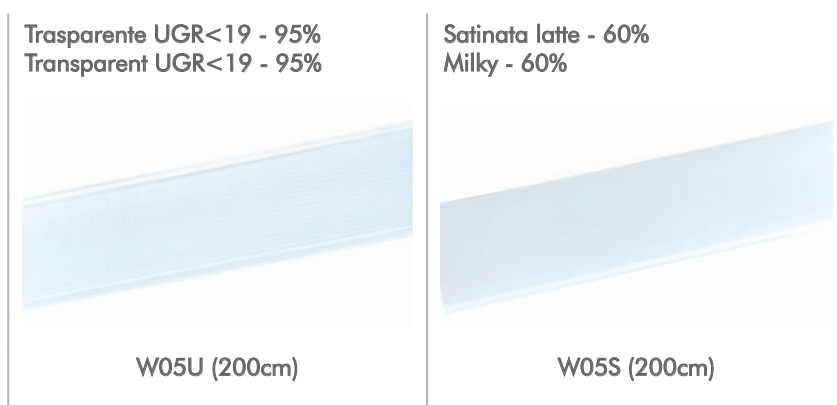

Accensioni / Ignitions

- Sensore Pir / Pir Sensor

Strip led / Led strip

Compatibile con le strip led Pro-Light della serie: / Compatible with Pro-Light LED strips of the series:

- COB
- PLUS
- ULTRA
- OVER
- SPECIAL

PA01

Profilo in XPS / XPS profile

Superficie / Surface

XPS - Profile series

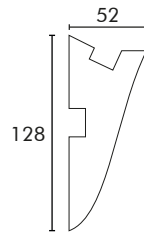

Codice prodotto Item code	Lunghezza Length	Finitura Finish
PA01	100+100cm	N/A

PA01 è un kit / PA01 is a kit

XPS	
WS1709 (prof.)	100+100cm
W01S (cover)	

Accessori / Accessories

PA01-AI	Angolo interno/Internal corner
PA01-AE	Angolo esterno / Outer corner

PA01 ————— ● XPS - Profile series

KIT profilo in XPS per realizzazioni estetiche e decorative con illuminazione LED integrata. Ideale per realizzare cornici luminose, applique, illuminazione diffusa. Compatibile con tutte le strip led Pro-Light. L'articolo non è rifinito e necessita di verniciatura con le normali pitture da muro. Può essere fissato al muro mediante colla o sigillante multiuso verniciabile.

XPS profile KIT for aesthetic and decorative creations with integrated LED lighting. Ideal for creating luminous frames, appliques, diffused lighting. Compatible with all Pro-Light LED strips. The item needs finishing with standard wall paints. The item can be fixed to the wall using glue or paintable multipurpose sealant.

PA03

Profilo in XPS / XPS profile

Superficie / Surface

XPS - Profile series

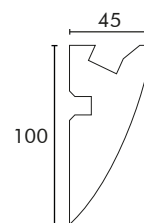

Codice prodotto Item code	Lunghezza Length	Finitura Finish
PA03	100+100cm	N/A

PA03 è un kit / PA03 is a kit

XPS	
WS1709 (prof.)	100+100cm
W01S (cover)	

Accessori / Accessories

PA03-AI	Angolo interno/Internal corner
PA03-AE	Angolo esterno / Outer corner

PA03 ————— ● XPS - Profile series

KIT profilo in XPS per realizzazioni estetiche e decorative con illuminazione LED integrata. Ideale per realizzare cornici luminose, applique, illuminazione diffusa. Compatibile con tutte le strip led Pro-Light. L'articolo non è rifinito e necessita di verniciatura con le normali pitture da muro. Può essere fissato al muro mediante colla o sigillante multiuso verniciabile.

XPS profile KIT for aesthetic and decorative creations with integrated LED lighting. Ideal for creating luminous frames, appliques, diffused lighting. Compatible with all Pro-Light LED strips. The item needs finishing with standard wall paints. The item can be fixed to the wall using glue or paintable multipurpose sealant.

PA05

Superficie / Surface

Profilo in XPS / XPS profile

XPS - Profile series

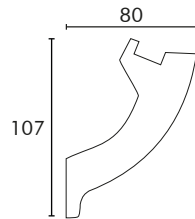

Codice prodotto Item code	Lunghezza Length	Finitura Finish
PA05	100+100cm	N/A

PA05 è un kit / PA05 is a kit

XPS	
WS1709 (prof.)	100+100cm
W01S (cover)	

Accessori / Accessories

PA05-AI	Angolo interno/Internal corner
PA05-AE	Angolo esterno / Outer corner

PA05 ————— ● XPS - Profile series

KIT profilo in XPS per realizzazioni estetiche e decorative con illuminazione LED integrata. Ideale per realizzare cornici luminose, applique, illuminazione diffusa. Compatibile con tutte le strip led Pro-Light. L'articolo non è rifinito e necessita di verniciatura con le normali pitture da muro. Può essere fissato al muro mediante colla o sigillante multiuso verniciabile.

XPS profile KIT for aesthetic and decorative creations with integrated LED lighting. Ideal for creating luminous frames, appliques, diffused lighting. Compatible with all Pro-Light LED strips. The item needs finishing with standard wall paints. The item can be fixed to the wall using glue or paintable multipurpose sealant.

PA07

Superficie / Surface

Profilo in XPS / XPS profile

XPS - Profile series

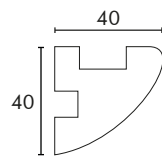

Codice prodotto Item code	Lunghezza Length	Finitura Finish
PA07	100+100cm	N/A

PA07 è un kit / PA07 is a kit

XPS	
WS1709 (prof.)	100+100cm
W01S (cover)	

Accessori / Accessories

PA07-AI	Angolo interno/Internal corner
PA07-AE	Angolo esterno / Outer corner

PA07 ————— ● XPS - Profile series

KIT profilo in XPS per realizzazioni estetiche e decorative con illuminazione LED integrata. Ideale per realizzare cornici luminose, applique, illuminazione diffusa. Compatibile con tutte le strip led Pro-Light. L'articolo non è rifinito e necessita di verniciatura con le normali pitture da muro. Può essere fissato al muro mediante colla o sigillante multiuso verniciabile.

XPS profile KIT for aesthetic and decorative creations with integrated LED lighting. Ideal for creating luminous frames, appliques, diffused lighting. Compatible with all Pro-Light LED strips. The item needs finishing with standard wall paints. The item can be fixed to the wall using glue or paintable multipurpose sealant.

AN04

Superficie / Surface

Profilo in XPS / XPS profile

XPS - Profile series

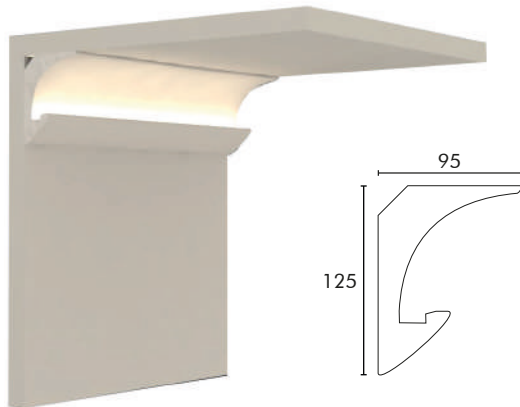

Codice prodotto Item code	Lunghezza Length	Finitura Finish
AN04	100+100cm	N/A

AN04 è un kit / AN04 is a kit

XPS	
WS1709 (prof.)	100+100cm
W01S (cover)	

Accessori / Accessories

AN04-AI	Angolo interno/Internal corner
AN04-AE	Angolo esterno / Outer corner

AN04 ————— ● XPS - Profile series

KIT profilo in XPS per realizzazioni estetiche e decorative con illuminazione LED integrata. Ideale per realizzare cornici luminose, applique, illuminazione diffusa. Compatibile con tutte le strip led Pro-Light. L'articolo non è rifinito e necessita di verniciatura con le normali pitture da muro. Può essere fissato al muro mediante colla o sigillante multiuso verniciabile.

XPS profile KIT for aesthetic and decorative creations with integrated LED lighting. Ideal for creating luminous frames, appliques, diffused lighting. Compatible with all Pro-Light LED strips. The item needs finishing with standard wall paints. The item can be fixed to the wall using glue or paintable multipurpose sealant.

AN06

Superficie / Surface

Profilo in XPS / XPS profile

XPS - Profile series

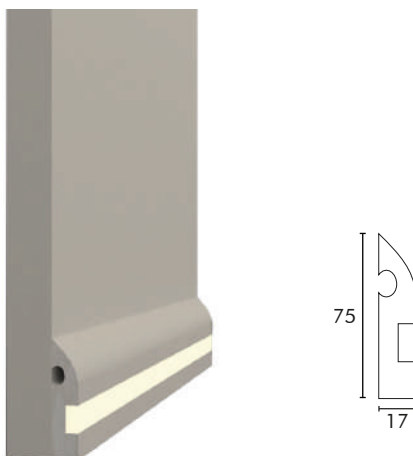

Codice prodotto Item code	Lunghezza Length	Finitura Finish
AN06	100+100cm	N/A

AN06 è un kit / AN06 is a kit

XPS	
WS1709 (prof.)	100+100cm
W01S (cover)	

Accessori / Accessories

AN06-AI	Angolo interno/Internal corner
AN06-AE	Angolo esterno / Outer corner

AN06 ————— ● XPS - Profile series

KIT profilo in XPS per realizzazioni estetiche e decorative con illuminazione LED integrata. Ideale per realizzare cornici luminose, applique, illuminazione diffusa. Compatibile con tutte le strip led Pro-Light. L'articolo non è rifinito e necessita di verniciatura con le normali pitture da muro. Può essere fissato al muro mediante colla o sigillante multiuso verniciabile.

XPS profile KIT for aesthetic and decorative creations with integrated LED lighting. Ideal for creating luminous frames, appliques, diffused lighting. Compatible with all Pro-Light LED strips. The item needs finishing with standard wall paints. The item can be fixed to the wall using glue or paintable multipurpose sealant.





myway series — Custom collection

Myway è la serie di prodotti finiti personalizzati Pro-Light, pensata per abbracciare le esigenze di ogni professionista del settore del mobile e arredo in generale.

I myway sono prodotti finiti, costruiti ed assemblati sulla base delle specifiche tecniche richieste in fase di ordine.

Gli articoli myway sono lampade create mediante l'assemblaggio di profili in alluminio, strip led, copertura e terminali.

È possibile personalizzare la tipologia di strip led utilizzata, temperatura colore, finitura del profilo e dello schermo, Watt, lunghezza e tipologia di cablaggio.





Myway is the series of Pro-Light customized finished products, designed to embrace the needs of every professional in the furniture and furnishing sector in general.

Myway items are finished products, built and assembled on the basis of the technical specifications requested in the order.





Myway articles are lamps created by assembling aluminum profiles, led strips, covers and terminals.

It is possible to customize the type of LED strip used, color temperature, profile and screen finish, Watt, length and type of wiring.



Fonte di luce
Light source

-  Plus 2835 ●
-  Cob Cri>90
-  Ultra 2216 Cri>90
-  Over 2835 150lm/w
-  Special rgb/dual

Temperatura colore
Color temperature

-  2700°K
-  3000°K ●
-  4000°K ●
-  5000°K
-  6000°K

Finiture
Finishes

-  Aluminium ●
-  Black
-  RAL

● Configurazioni standard
Standard configurations

myway series — Creazione del codice prodotto / Product code creation

Per conoscere il codice del prodotto myway da ordinare è necessario aver preventivamente deciso ogni sua caratteristica.

To know the code of the myway product to be ordered, it is necessary to have previously decided on each of its characteristics.

Per ciascun prodotto myway sono presenti delle configurazioni standard (che rappresentano le più richieste dai nostri clienti).

For each myway product there are standard configurations (which represent the most requested by our customers).

Qualora tali configurazioni standard non si addicessero alle vostre esigenze, è possibile creare il codice del prodotto da voi richiesto seguendo lo schema di seguito.

If these standard configurations do not suit your needs, it is possible to create the product code you require by following the diagram below.

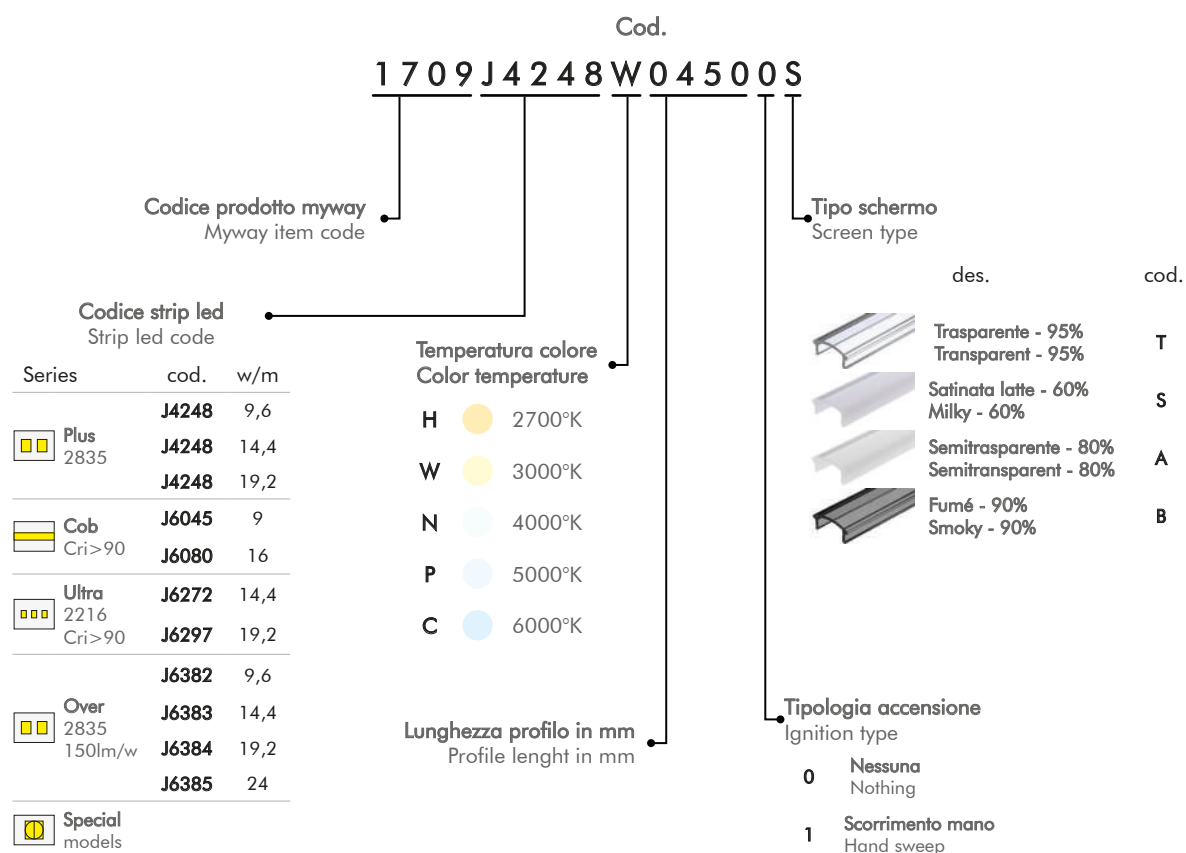

Altre personalizzazioni disponibili - codice fornito su richiesta
Other customizations available - item code provided upon request

- Finiture / Finishes
- Lunghezza cavo / Cable lenght
- Tipo di cablaggio / Wiring options

1709myway

Prodotto finito realizzato su misura / Tailor made finished product

Superficie o incasso / Surface or recessed

myway - Profile series



1709myway — myway - Profile series

Lampada lineare per integrazione a vista o incasso su ripiano o pensile.

Linear lamp for visible integration or recessed on shelf or wall unit.

Profilo in alluminio completo di schermo opale in policarbonato, strip led, terminali di chiusura e clips in alluminio. Il prodotto viene fornito già cablato con cavo di 1 metro dotato di connettore rapido Pro-Light. Driver non incluso.

Aluminum profile complete with opal polycarbonate screen, LED strip, end caps and aluminum clips. The product is supplied already wired with a 1 meter cable equipped with a Pro-Light quick connector. Led driver not included.

In fase di ordine è possibile richiedere una vasta gamma di personalizzazioni, in modo da rendere il prodotto perfettamente compatibile con le proprie esigenze.

When ordering, it is possible to request a wide range of customizations, in order to make the product perfectly compatible with customer needs.

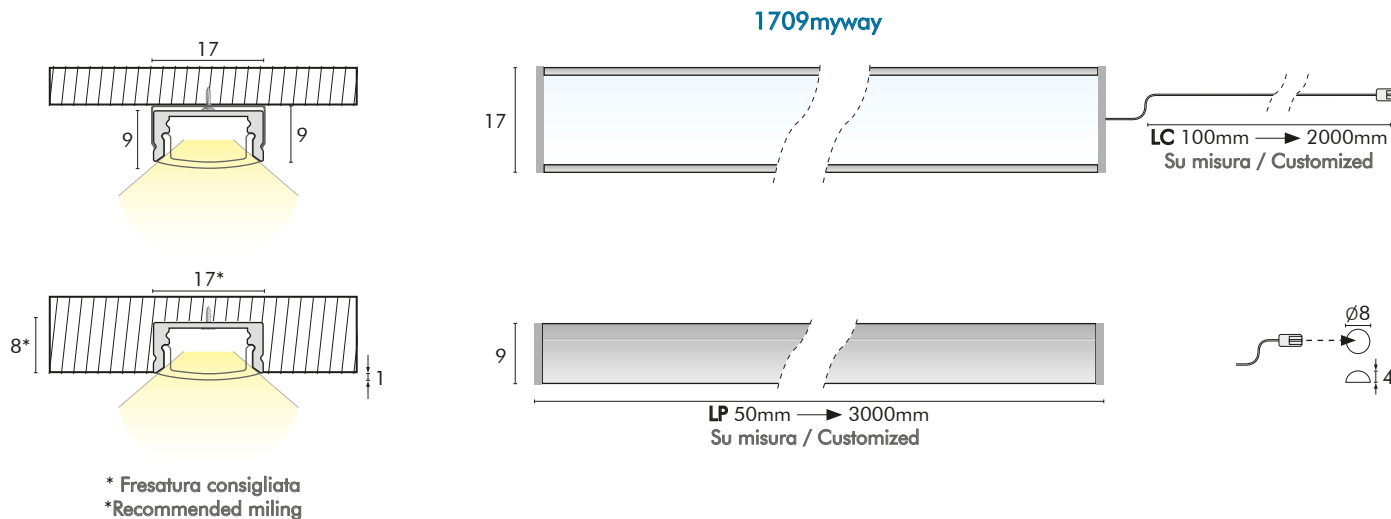



Strip LED 24V — Configurazioni standard / Standard configurations

°K	LP (mm)	LC (mm)	Watt	Lumen	Cod.
3000°K	450	1000	4,30	430	1709J4248W04500S
	600	1000	5,70	570	1709J4248W06000S
	900	1000	8,60	860	1709J4248W09000S
	1200	1000	11,50	1150	1709J4248W12000S
	1500	1000	14,40	1440	1709J4248W15000S
	1800	1000	17,20	1720	1709J4248W18000S
4000°K	450	1000	4,30	430	1709J4248N04500S
	600	1000	5,70	570	1709J4248N06000S
	900	1000	8,60	860	1709J4248N09000S
	1200	1000	11,50	1150	1709J4248N12000S
	1500	1000	14,40	1440	1709J4248N15000S
	1800	1000	17,20	1720	1709J4248N18000S

LP = lunghezza profilo / LP = profile length
LC = lunghezza cavo / LC = cable length

Personalizzazioni disponibili - seguire guida creazione codice
Customizations available - follow code creation guide

- 2700°K / 5000°K / 6000°K
- Lunghezza profilo / Profile length
- Potenza W/m / Power W/m
- Altre tipologie di strip led / Other strip led options
- Tipologia schermo / Screen type
- Tipologia accensione / Ignition type

Altre personalizzazioni disponibili - codice fornito su richiesta
Other customizations available - item code provided upon request

- Finiture / Finishes
- Lunghezza cavo / Cable length
- Tipo di cablaggio / Wiring options

Finiture Finishes

- Aluminium ●
- Black
- RAL

Fonte di luce Light source

- Plus 2835 ●
- Cob Cri > 90
- Ultra 2216 Cri > 90
- Over 2835 150lm/w
- Special rgbw/dual

Temperatura colore Color temperature

- 2700°K
- 3000°K ●
- 4000°K ●
- 5000°K
- 6000°K

- Configurazioni standard
Standard configurations

0908myway

Prodotto finito realizzato su misura / Tailor made finished product

Superficie o incasso / Surface or recessed

myway - Profile series



0908myway — myway - Profile series

Lampada lineare per integrazione a vista o incasso su ripiano o pensile.

Linear lamp for visible integration or recessed on shelf or wall unit.

Profilo in alluminio completo di schermo opale in policarbonato, strip led, terminali di chiusura e clips in alluminio. Il prodotto viene fornito già cablato con cavo di 1 metro dotato di connettore rapido Pro-Light. Driver non incluso.

Aluminum profile complete with opal polycarbonate screen, LED strip, end caps and aluminum clips. The product is supplied already wired with a 1 meter cable equipped with a Pro-Light quick connector. Led driver not included.

In fase di ordine è possibile richiedere una vasta gamma di personalizzazioni, in modo da rendere il prodotto perfettamente compatibile con le proprie esigenze.

When ordering, it is possible to request a wide range of customizations, in order to make the product perfectly compatible with customer needs.

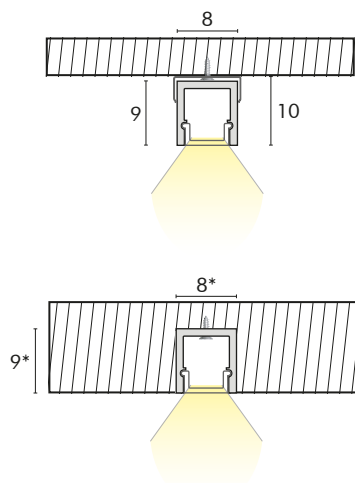

* Fresatura consigliata
*Recommended milling

0908myway

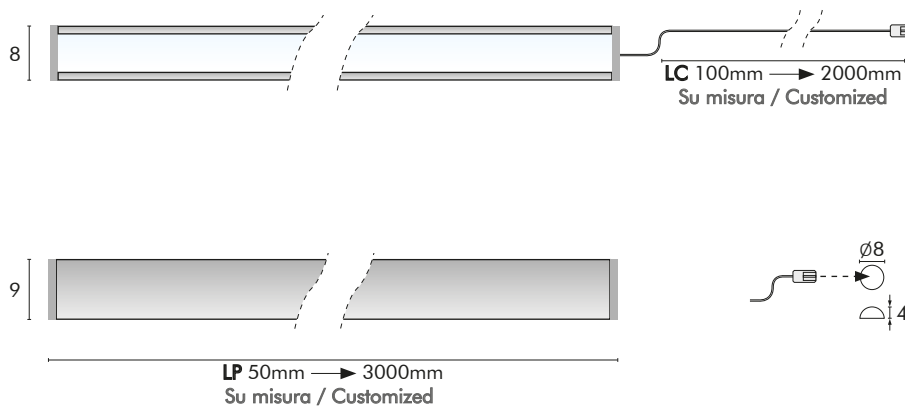



Strip LED 24V — Configurazioni standard / Standard configurations

°K	LP (mm)	LC (mm)	Watt	Lumen	Cod.
3000°K	450	1000	4,50	430	0908J6387W04500S
	600	1000	6,00	570	0908J6387W06000S
	900	1000	9,00	860	0908J6387W09000S
	1200	1000	12,00	1150	0908J6387W12000S
	1500	1000	15,00	1440	0908J6387W15000S
	1800	1000	18,00	1720	0908J6387W18000S
4000°K	450	1000	4,50	430	0908J6387N04500S
	600	1000	6,00	570	0908J6387N06000S
	900	1000	9,00	860	0908J6387N09000S
	1200	1000	12,00	1150	0908J6387N12000S
	1500	1000	15,00	1440	0908J6387N15000S
	1800	1000	18,00	1720	0908J6387N18000S

LP = lunghezza profilo / LP = profile length
LC = lunghezza cavo / LC = cable length

Finiture Finishes

- Aluminium
- RAL

Fonte di luce Light source

- Special slim

Temperatura colore Color temperature

- 2700°K
- 3000°K
- 4000°K

- Configurazioni standard
Standard configurations

Personalizzazioni disponibili - seguire guida creazione codice
Customizations available - follow code creation guide

- 2700°K
- Lunghezza profilo / Profile length
- Potenza W/m / Power W/m
- Altre tipologie di strip led / Other strip led options
- Tipologia accensione / Ignition type

Altre personalizzazioni disponibili - codice fornito su richiesta
Other customizations available - item code provided upon request

- Finiture / Finishes
- Lunghezza cavo / Cable length
- Tipo di cablaggio / Wiring options

2309myway

Incasso / Recessed

Prodotto finito realizzato su misura / Tailor made finished product

myway - Profile series



2309myway — myway - Profile series

Lampada lineare per integrazione a incasso su ripiano o pensile.

Profilo in alluminio completo di schermo opale in policarbonato, strip led, terminali di chiusura e clips in alluminio. Il prodotto viene fornito già cablato con cavo di 1 metro dotato di connettore rapido Pro-Light. Driver non incluso.

In fase di ordine è possibile richiedere una vasta gamma di personalizzazioni, in modo da rendere il prodotto perfettamente compatibile con le proprie esigenze.

Linear lamp for recessed integration on shelf or wall unit.

Aluminum profile complete with opal polycarbonate screen, LED strip, end caps and aluminum clips. The product is supplied already wired with a 1 meter cable equipped with a Pro-Light quick connector. Led driver not included.

When ordering, it is possible to request a wide range of customizations, in order to make the product perfectly compatible with customer needs.

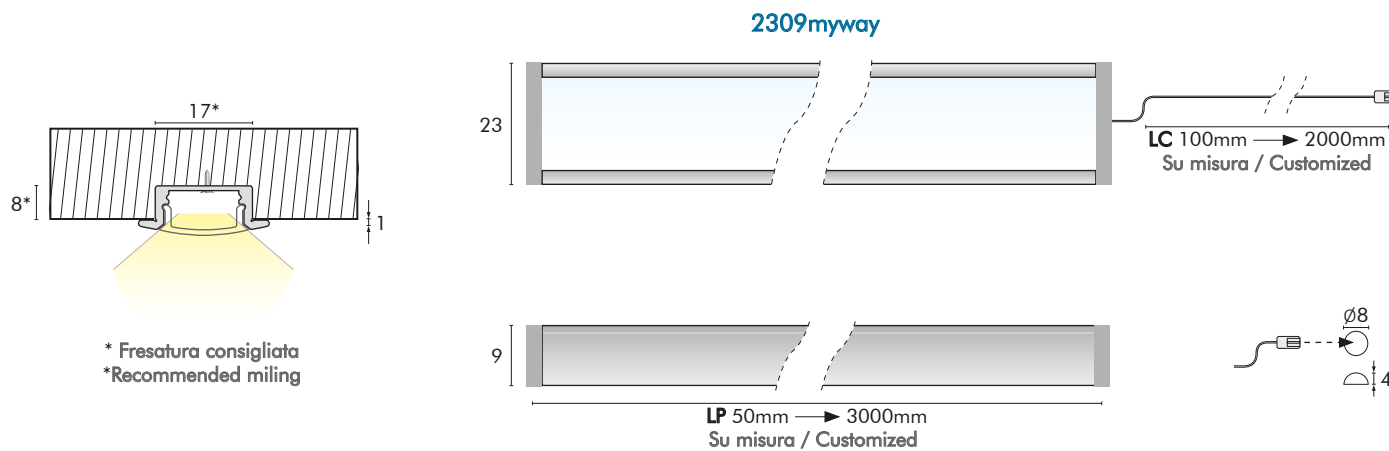

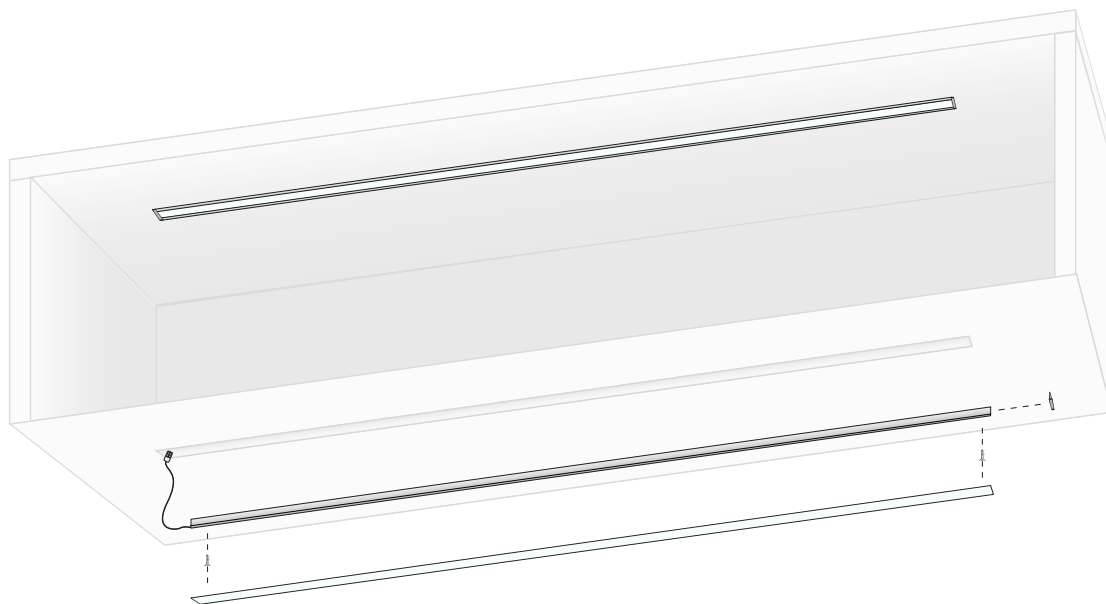

Strip LED 24V — Configurazioni standard / Standard configurations

°K	LP (mm)	LC (mm)	Watt	Lumen	Cod.
3000°K	450	1000	4,30	430	2309J4248W04500S
	600	1000	5,70	570	2309J4248W06000S
	900	1000	8,60	860	2309J4248W09000S
	1200	1000	11,50	1150	2309J4248W12000S
	1500	1000	14,40	1440	2309J4248W15000S
	1800	1000	17,20	1720	2309J4248W18000S
4000°K	450	1000	4,30	430	2309J4248N04500S
	600	1000	5,70	570	2309J4248N06000S
	900	1000	8,60	860	2309J4248N09000S
	1200	1000	11,50	1150	2309J4248N12000S
	1500	1000	14,40	1440	2309J4248N15000S
	1800	1000	17,20	1720	2309J4248N18000S

LP = lunghezza profilo / LP = profile length
 LC = lunghezza cavo / LC = cable length

Personalizzazioni disponibili - seguire guida creazione codice
 Customizations available - follow code creation guide

- 2700°K / 5000°K / 6000°K
- Lunghezza profilo / Profile length
- Potenza W/m / Power W/m
- Altre tipologie di strip led / Other strip led options
- Tipologia schermo / Screen type
- Tipologia accensione / Ignition type

Altre personalizzazioni disponibili - codice fornito su richiesta
 Other customizations available - item code provided upon request

- Finiture / Finishes
- Lunghezza cavo / Cable length
- Tipo di cablaggio / Wiring options

Finiture
Finishes

- Aluminium ●
- RAL

Fonte di luce
Light source

- Plus 2835 ●
- Cob Cri > 90
- Ultra 2216 Cri > 90
- Over 2835 150lm/w
- Special rgbw/dual

Temperatura colore
Color temperature

- 2700°K
- 3000°K ●
- 4000°K ●
- 5000°K
- 6000°K

● Configurazioni standard
Standard configurations



1818myway ————— ● myway - Profile series

Lampada lineare per integrazione ad angolo su ripiano o pensile.

Profilo in alluminio completo di schermo opale in policarbonato, strip led, terminali di chiusura e clips in alluminio. Il prodotto viene fornito già cablato con cavo di 1 metro dotato di connettore rapido Pro-Light. Driver non incluso.

In fase di ordine è possibile richiedere una vasta gamma di personalizzazioni, in modo da rendere il prodotto perfettamente compatibile con le proprie esigenze.

Linear lamp for corner integration on shelf or wall unit.

Aluminum profile complete with opal polycarbonate screen, LED strip, end caps and aluminum clips. The product is supplied already wired with a 1 meter cable equipped with a Pro-Light quick connector. Driver not included.

When ordering, it is possible to request a wide range of customizations, in order to make the product perfectly compatible with your needs.

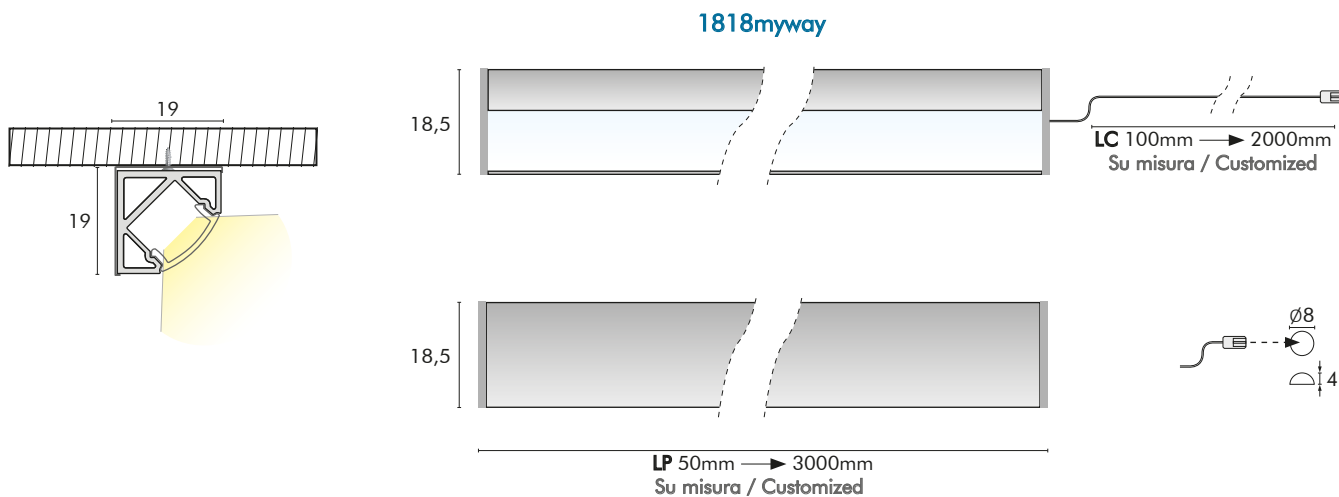



Strip LED 24V — Configurazioni standard / Standard configurations

°K	LP (mm)	LC (mm)	Watt	Lumen	Cod.
3000°K	450	1000	4,30	430	1818J4248W04500S
	600	1000	5,70	570	1818J4248W06000S
	900	1000	8,60	860	1818J4248W09000S
	1200	1000	11,50	1150	1818J4248W12000S
	1500	1000	14,40	1440	1818J4248W15000S
	1800	1000	17,20	1720	1818J4248W18000S
4000°K	450	1000	4,30	430	1818J4248N04500S
	600	1000	5,70	570	1818J4248N06000S
	900	1000	8,60	860	1818J4248N09000S
	1200	1000	11,50	1150	1818J4248N12000S
	1500	1000	14,40	1440	1818J4248N15000S
	1800	1000	17,20	1720	1818J4248N18000S

LP = lunghezza profilo / LP = profile length
LC = lunghezza cavo / LC = cable length

Personalizzazioni disponibili - seguire guida creazione codice
Customizations available - follow code creation guide

- 2700°K / 5000°K / 6000°K
- Lunghezza profilo / Profile length
- Potenza W/m / Power W/m
- Altre tipologie di strip led / Other strip led options
- Tipologia schermo / Screen type
- Tipologia accensione / Ignition type

Altre personalizzazioni disponibili - codice fornito su richiesta
Other customizations available - item code provided upon request

- Finiture / Finishes
- Lunghezza cavo / Cable length
- Tipo di cablaggio / Wiring options

Finiture Finishes

- Aluminium ●
- RAL

Fonte di luce Light source

- Plus 2835 ●
- Cob Cri > 90
- Ultra 2216 Cri > 90
- Over 2835 150lm/w
- Special rgbw/dual

Temperatura colore Color temperature

- 2700°K
- 3000°K ●
- 4000°K ●
- 5000°K
- 6000°K

- Configurazioni standard
Standard configurations

1616myway

Angolare / Angular

Prodotto finito realizzato su misura / Tailor made finished product

myway - Profile series



1616myway — myway - Profile series

Lampada lineare per integrazione ad angolo su ripiano o pensile.

Profilo in alluminio completo di schermo opale in policarbonato, strip led, terminali di chiusura e clips in alluminio. Il prodotto viene fornito già cablato con cavo di 1 metro dotato di connettore rapido Pro-Light. Driver non incluso.

In fase di ordine è possibile richiedere una vasta gamma di personalizzazioni, in modo da rendere il prodotto perfettamente compatibile con le proprie esigenze.

Linear lamp for corner integration on shelf or wall unit.

Aluminum profile complete with opal polycarbonate screen, LED strip, end caps and aluminum clips. The product is supplied already wired with a 1 meter cable equipped with a Pro-Light quick connector. Driver not included.

When ordering, it is possible to request a wide range of customizations, in order to make the product perfectly compatible with your needs.

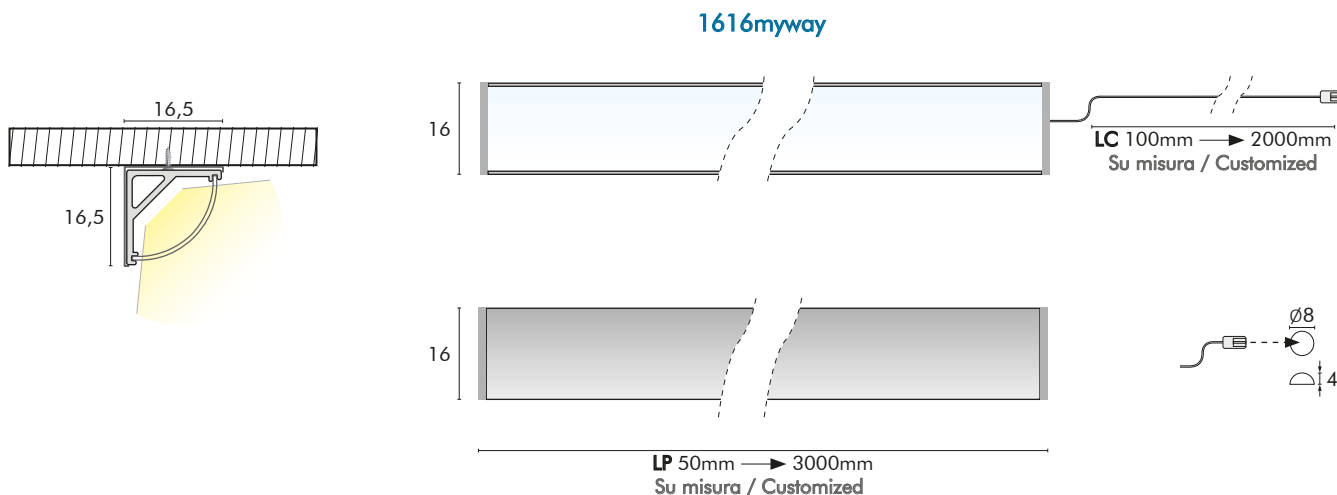



Strip LED 24V — Configurazioni standard / Standard configurations

°K	LP (mm)	LC (mm)	Watt	Lumen	Cod.
3000°K	450	1000	4,30	430	1616J4248W04500S
	600	1000	5,70	570	1616J4248W06000S
	900	1000	8,60	860	1616J4248W09000S
	1200	1000	11,50	1150	1616J4248W12000S
	1500	1000	14,40	1440	1616J4248W15000S
	1800	1000	17,20	1720	1616J4248W18000S
4000°K	450	1000	4,30	430	1616J4248N04500S
	600	1000	5,70	570	1616J4248N06000S
	900	1000	8,60	860	1616J4248N09000S
	1200	1000	11,50	1150	1616J4248N12000S
	1500	1000	14,40	1440	1616J4248N15000S
	1800	1000	17,20	1720	1616J4248N18000S

LP = lunghezza profilo / LP = profile length
 LC = lunghezza cavo / LC = cable length

Personalizzazioni disponibili - seguire guida creazione codice
 Customizations available - follow code creation guide

- 2700°K / 5000°K / 6000°K
- Lunghezza profilo / Profile length
- Potenza W/m / Power W/m
- Altre tipologie di strip led / Other strip led options
- Tipologia accensione / Ignition type

Altre personalizzazioni disponibili - codice fornito su richiesta
 Other customizations available - item code provided upon request

- Finiture / Finishes
- Lunghezza cavo / Cable length
- Tipo di cablaggio / Wiring options

Finiture Finishes

- Aluminium ●
- RAL

Fonte di luce Light source

- Plus 2835 ●
- Cob Cri > 90
- Ultra 2216 Cri > 90
- Over 2835 150lm/w
- Special rgbw/dual

Temperatura colore Color temperature

- 2700°K
- 3000°K ●
- 4000°K ●
- 5000°K
- 6000°K

- Configurazioni standard
Standard configurations

Residential Series

Illuminazione residenziale e per alberghi / Residential and hotel lighting

Superficie, incasso e sospensione / Surface, recessed and suspension

Residential series

Smart

Faretto downlight / Downlight



I1209



I1201



I1202



I1204



I1205



I1206



I1208



I1219



I1212

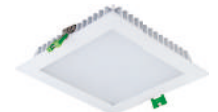

I1214



I1216



I1218

Modulo

Faretto downlight modulare / Modular spotlight



I309



I312



I315



I343



I344



I347



I350



I353



I354



I349



I351

Residential series

Illuminazione residenziale e per alberghi / Residential and hotel lighting

Superficie, incasso e sospensione / Surface, recessed and suspension

Residential series

Mini

Faretto mini / Mini downlight



P7013



P7017



P7030



P7060



P7022



P7027



P7055



E7066



I7243



I7283



I7253



I7263



I7273



I1406



I1412

Advance

Faretto downlight / Downlight



H2_15



H1118



I3909



I3901



I3902



I3904



I3905



I3908



I2909



I2900



I2901

I120x

Faretto downlight / Downlight

Incasso / Recessed

Smart - Residential series



Finiture / Finishes

○ Bianco / White

🌈 RAL (su richiesta) / RAL (upon request)

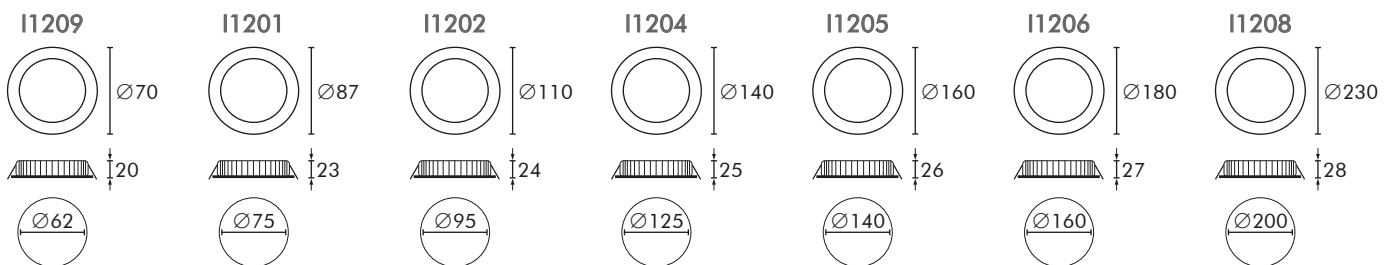

I120x — Smart - Residential series

Faretto LED da incasso a basso profilo, luce diffusa.
Alta affidabilità, backlit, pcb in metal core.
Driver Eaglerise incluso.

Low profile recessed LED spotlight, diffused light.
High reliability, backlit, metal core pcb.
Eaglerise driver included.

°K	Ø(mm)	Øcut(mm)	CRI	Watt	Lumen	Emit °	Current	Cod.
3000°K	70	62	>90	4,50	400	100°	350mA	I1209WW
	87	75	>90	8,00	720	100°	350mA	I1201WW
	110	95	>90	8,00	720	100°	350mA	I1202WW
	140	125	>90	11,00	990	100°	350mA	I1204WW
	160	140	>90	15,00	1350	100°	350mA	I1205WW
	180	160	>90	15,00	1620	100°	350mA	I1206WW
	230	200	>90	23,00	2070	100°	350mA	I1208WW
4000°K	70	62	>90	4,50	420	100°	350mA	I1209NW
	87	75	>90	8,00	760	100°	350mA	I1201NW
	110	95	>90	8,00	760	100°	350mA	I1202NW
	140	125	>90	11,00	1045	100°	350mA	I1204NW
	160	140	>90	15,00	1425	100°	350mA	I1205NW
	180	160	>90	15,00	1710	100°	350mA	I1206NW
	230	200	>90	23,00	2185	100°	350mA	I1208NW

I121x

Incasso / Recessed

Faretto downlight / Downlight

Smart - Residential series



Finiture / Finishes

- Bianco / White
- RAL (su richiesta) / RAL (upon request)

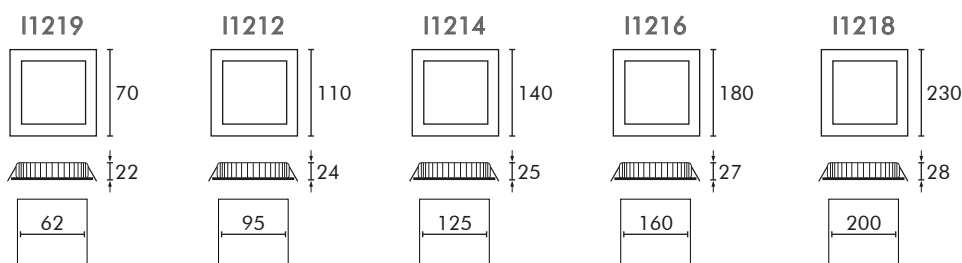

I121x — Smart - Residential series

Faretto LED quadrato da incasso a basso profilo, luce diffusa.
Alta affidabilità, backlit, pcb in metal core.
Driver Eaglerise incluso.

Squared low profile recessed LED spotlight, diffused light.
High reliability, backlit, metal core pcb.
Eaglerise driver included.

°K	dim(mm)	cut(mm)	CRI	Watt	Lumen	Emit °	Current	Cod.
3000°K	70x70	62x62	>90	4,50	400	100°	350mA	I1219WW
	110x110	95x95	>90	11,00	990	100°	350mA	I1212WW
	140x140	125x125	>90	15,00	1350	100°	350mA	I1214WW
	180x180	160x160	>90	18,00	1620	100°	350mA	I1216WW
	230x230	200x200	>90	23,00	2070	100°	350mA	I1218WW
4000°K	70x70	62x62	>90	4,50	420	100°	350mA	I1219NW
	110x110	95x95	>90	11,00	1050	100°	350mA	I1212NW
	140x140	125x125	>90	15,00	1425	100°	350mA	I1214NW
	180x180	160x160	>90	18,00	1710	100°	350mA	I1216NW
	230x230	200x200	>90	23,00	2185	100°	350mA	I1218NW

I309

Incasso / Recessed

Modulo led / Led module

Modulo - Residential series

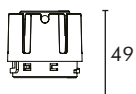

I309 Modulo - Residential series

Modulo LED ad innesto rapido per ghiera serie Modulo.
Lente standard da 38° UGR<19 inclusa, supporto lente incluso.
Driver Eaglerise incluso.

Quick-fit LED module for Modulo series rings.
Standard 38° UGR<19 lens included, lens holder included.
Eaglerise driver included.

°K	Ø(mm)	UGR	CRI	Watt	Lumen	Emit °	Current	Cod.
2700°K	55	<19	>90	9,00	829	38°	200mA	I309HW
3000°K	55	<19	>90	9,00	878	38°	200mA	I309WW
4000°K	55	<19	>90	9,00	932	38°	200mA	I309NW

Accessori / Accessories

Cod.	Descr.
I381	Lente 15° / 15° lens
I383	Lente 24° / 24° lens
I387	Lente 55° / 55° lens
I3-H	Diffusore UGR<13 / UGR<13 diffuser

I312 / I315

Incasso / Recessed

Modulo led / Led module

Modulo - Residential series

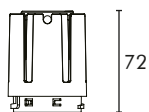

I312/I315 • Modulo - Residential series

Modulo LED ad innesto rapido per ghiera serie Modulo.
Lente standard da 38° UGR<19 inclusa, supporto lente incluso.
Driver Eaglerise incluso.

Quick-fit LED module for Modulo series rings.
Standard 38° UGR<19 lens included, lens holder included.
Eaglerise driver included.

°K	Ø(mm)	UGR	CRI	Watt	Lumen	Emit °	Current	Cod.
3000°K	55	<19	>90	12,00	1152	38°	300mA	I312WW
	55	<19	>90	15,00	1289	38°	350mA	I315WW
4000°K	55	<19	>90	12,00	1286	38°	300mA	I312NW
	55	<19	>90	15,00	1412	38°	350mA	I315NW

Accessori / Accessories

Cod.	Descr.
I381	Lente 15° / 15° lens
I383	Lente 24° / 24° lens
I387	Lente 55° / 55° lens
I3-H	Diffusore UGR<13 / UGR<13 diffuser

I343

Ghiere per I309-I312-I315 / Trims for I309-I312-I315

Incasso / Recessed

Modulo - Residential series



Finiture / Finishes

- Bianco / White
- RAL (su richiesta) / RAL (upon request)

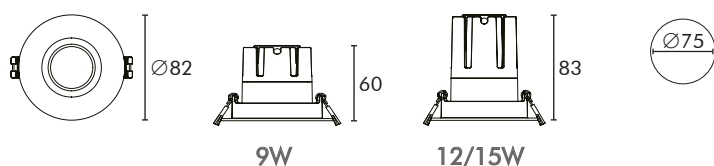

I343 —● Modulo - Residential series

Ghiera ad innesto rapido per moduli led I309, I312 e I315.

Quick-fit trim for I309, I312 and I315 led modules.

Ø(mm)	Øcut(mm)	Cod.
82	75	I343

Accessori / Accessories

Cod.	Descr.
I381	Lente 15° / 15° lens
I383	Lente 24° / 24° lens
I387	Lente 55° / 55° lens
I3-H	Diffusore UGR<13 / UGR<13 diffuser

I344

Incasso / Recessed

Ghiere per I309-I312-I315 / Trims for I309-I312-I315

Modulo - Residential series

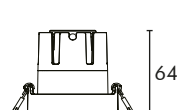
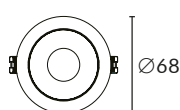

9W

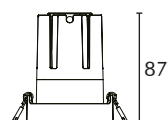

12/15W



Finiture / Finishes

○ Bianco / White

● RAL (su richiesta) / RAL (upon request)



I344 —● Modulo - Residential series

Ghiera ad innesto rapido per moduli led I309, I312 e I315.

Quick-fit trim for I309, I312 and I315 led modules.

Ø(mm)	Øcut(mm)	Cod.
68	60	I344

Accessori / Accessories

Cod.	Descr.
I381	Lente 15° / 15° lens
I383	Lente 24° / 24° lens
I387	Lente 55° / 55° lens
I3-H	Diffusore UGR<13 / UGR<13 diffuser

I347

Incasso / Recessed

Ghiere per I309-I312-I315 / Trims for I309-I312-I315

Modulo - Residential series



Finiture / Finishes

- Bianco / White
- RAL (su richiesta) / RAL (upon request)

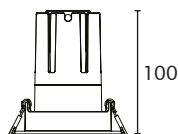
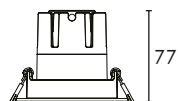
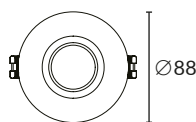

9W

12/15W



I347 — Modulo - Residential series

Ghiera ad innesto rapido per moduli led I309, I312 e I315.

Quick-fit trim for I309, I312 and I315 led modules.

Ø(mm)	Øcut(mm)	Cod.
88	75	I347

Accessori / Accessories

Cod.	Descr.
I381	Lente 15° / 15° lens
I383	Lente 24° / 24° lens
I387	Lente 55° / 55° lens
I3-H	Diffusore UGR<13 / UGR<13 diffuser

I350

Ghiere per I309-I312-I315 / Trims for I309-I312-I315

Incasso / Recessed

Modulo - Residential series

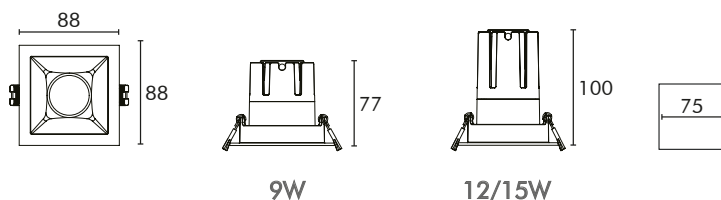

Finiture / Finishes

- Bianco / White
- RAL (su richiesta) / RAL (upon request)



I350 —● Modulo - Residential series

Ghiera ad innesto rapido per moduli led I309, I312 e I315.

Quick-fit trim for I309, I312 and I315 led modules.

dim(mm)	cut(mm)	Cod.
88x88	75x75	I350

Accessori / Accessories

Cod.	Descr.
I381	Lente 15° / 15° lens
I383	Lente 24° / 24° lens
I387	Lente 55° / 55° lens
I3-H	Diffusore UGR<13 / UGR<13 diffuser

I353

Incasso / Recessed

Ghiere per I309-I312-I315 / Trims for I309-I312-I315

Modulo - Residential series



Finiture / Finishes

○ Bianco / White

● RAL (su richiesta) / RAL (upon request)

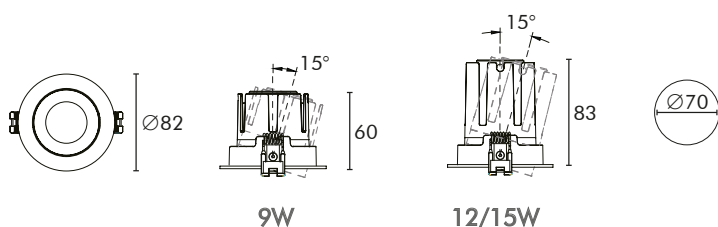

I353 — Modulo - Residential series

Ghiera ad innesto rapido per moduli led I309, I312 e I315.

Quick-fit trim for I309, I312 and I315 led modules.

Ø(mm)	Øcut(mm)	Cod.
82	70	I353

Accessori / Accessories

Cod.	Descr.
I381	Lente 15° / 15° lens
I383	Lente 24° / 24° lens
I387	Lente 55° / 55° lens
I3-H	Diffusore UGR<13 / UGR<13 diffuser

I354

Incasso / Recessed

Ghiere per I309-I312-I315 / Trims for I309-I312-I315

Modulo - Residential series

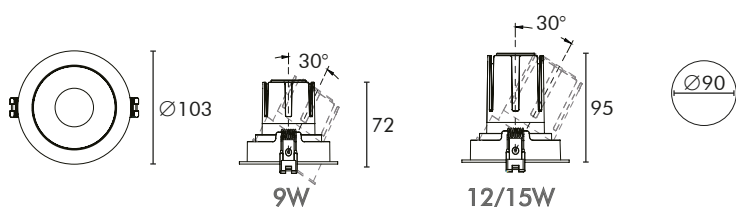

Finiture / Finishes

- Bianco / White
- RAL (su richiesta) / RAL (upon request)



I354 — Modulo - Residential series

Ghiera ad innesto rapido per moduli led I309, I312 e I315.

Quick-fit trim for I309, I312 and I315 led modules.

Ø(mm)	Øcut(mm)	Cod.
103	90	I354

Accessori / Accessories

Cod.	Descr.
I381	Lente 15° / 15° lens
I383	Lente 24° / 24° lens
I387	Lente 55° / 55° lens
I3-H	Diffusore UGR<13 / UGR<13 diffuser

I349

Incasso / Recessed

Ghiere per I309-I312-I315 / Trims for I309-I312-I315

Modulo - Residential series

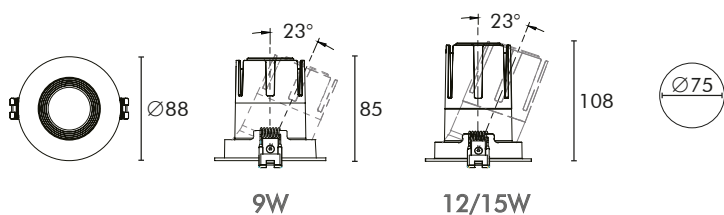

Finiture / Finishes

○ Bianco / White

● RAL (su richiesta) / RAL (upon request)



I349 — Modulo - Residential series

Ghiera ad innesto rapido per moduli led I309, I312 e I315.

Quick-fit trim for I309, I312 and I315 led modules.

Ø(mm)	Øcut(mm)	Cod.
88	75	I349

Accessori / Accessories

Cod.	Descr.
I381	Lente 15° / 15° lens
I383	Lente 24° / 24° lens
I387	Lente 55° / 55° lens
I3-H	Diffusore UGR<13 / UGR<13 diffuser

I351

Incasso / Recessed

Ghiere per I309-I312-I315 / Trims for I309-I312-I315

Modulo - Residential series

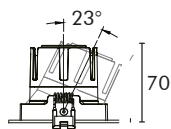
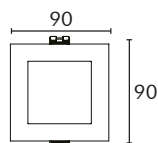
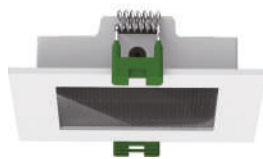

9W

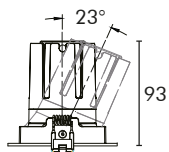

12/15W



Finiture / Finishes

○ Bianco / White

● RAL (su richiesta) / RAL (upon request)



I351 —● Modulo - Residential series

Ghiera ad innesto rapido per moduli led I309, I312 e I315.
Diffusore in vetro microprismatico.

Quick-fit trim for I309, I312 and I315 led modules.
Microprismatic glass diffuser.

dim(mm)	cut(mm)	Cod.
90x90	75x75	I351

Accessori / Accessories

Cod.	Descr.
I381	Lente 15° / 15° lens
I383	Lente 24° / 24° lens
I387	Lente 55° / 55° lens
I3-H	Diffusore UGR<13 / UGR<13 diffuser

P7013

Faretto downlight / Downlight

Incasso / Recessed

Mini - Residential series

Finiture / Finishes

- Bianco / White
- RAL (su richiesta) / RAL (upon request)

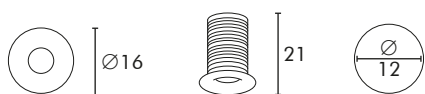

P7013 — Mini - Residential series

Faretto LED mini da incasso, luce spot.
Corpo in alluminio, riflettore in policarbonato.
Driver non incluso, alimentare a 350mA.

Recessed mini LED spotlight.
Aluminum body, polycarbonate reflector.
Driver not included, 350mA in.

°K	Ø(mm)	Øcut(mm)	CRI	Watt	Lumen	Emit °	Current	IP grade	Cod.
3000°K	16	12	>90	1,00	70	50°	350mA	IP54	P7013WW
4000°K	16	12	>90	1,00	72	50°	350mA	IP54	P7013NW

P7017

Incasso / Recessed

Faretto downlight / Downlight

Mini - Residential series



Finiture / Finishes

- Bianco / White
- RAL (su richiesta) / RAL (upon request)

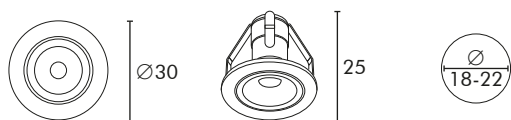

P7017 — Mini - Residential series

Faretto LED mini da incasso, luce spot.
Corpo in alluminio, lente in policarbonato.
Driver non incluso, alimentare a 350mA.

Recessed mini LED spotlight.
Aluminum body, polycarbonate lens.
Driver not included, 350mA in.

°K	Ø(mm)	Øcut(mm)	CRI	Watt	Lumen	Emit °	Current	IP grade	Cod.
3000°K	30	18-22	>90	1,00	70	50°	350mA	IP44	P7017WW
4000°K	30	18-22	>90	1,00	72	50°	350mA	IP44	P7017NW

P7030

Incasso / Recessed

Faretto downlight / Downlight

Mini - Residential series

Finiture / Finishes

- Bianco / White
- RAL (su richiesta) / RAL (upon request)

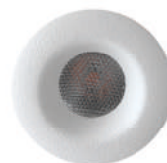
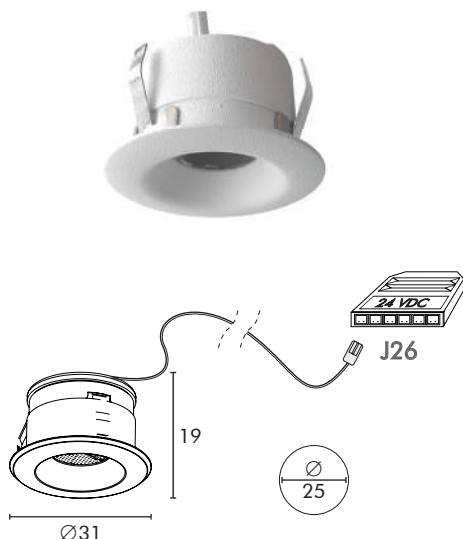

P7030 — Mini - Residential series

Faretto LED mini da incasso, luce spot.
 Corpo in alluminio, lente in policarbonato.
 Cavo da 2 metri con connettore maschio compatibile con J26
 (distributore da 1 a 6 vie).
 Driver non incluso, alimentare a 24V.

Recessed mini LED spotlight.
 Aluminum body, polycarbonate lens.
 2-metre cable with male connector compatible with J26
 (1 to 6-way distributor).
 Driver not included, 24V in.

°K	Ø(mm)	Øcut(mm)	CRI	Watt	Lumen	Emit °	Voltage	IP grade	Cod.
3000°K	31	25	>90	1,00	70	36°	24V	IP44	P7030WW
4000°K	31	25	>90	1,00	80	36°	24V	IP44	P7030NW

P7060

Incasso / Recessed

Faretto downlight / Downlight

Mini - Residential series

Finiture / Finishes

- Bianco / White
- RAL (su richiesta) / RAL (upon request)



P7060 — Mini - Residential series

Faretto LED mini da incasso, luce spot.
 Corpo in alluminio, lente in policarbonato.
 Cavo da 2 metri con connettore maschio compatibile con J26
 (distributore da 1 a 6 vie).
 Driver non incluso, alimentare a 24V.

Recessed mini LED spotlight.
 Aluminum body, polycarbonate lens.
 2-metre cable with male connector compatible with J26
 (1 to 6-way distributor).
 Driver not included, 24V in.

°K	Ø(mm)	Øcut(mm)	CRI	Watt	Lumen	Emit °	Voltage	IP grade	Cod.
3000°K	60	50	>90	3,00	210	36°	24V	IP44	P7060WW
4000°K	60	50	>90	3,00	240	36°	24V	IP44	P7060NW

P7022

Incasso / Recessed

Faretto downlight / Downlight

Mini - Residential series

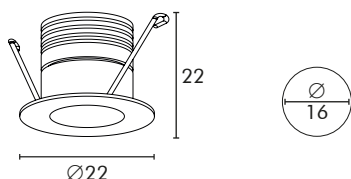

Finiture / Finishes

- Bianco / White
- RAL (su richiesta) / RAL (upon request)

P7022 — Mini - Residential series

Faretto LED mini da incasso, luce spot.
Corpo in alluminio, riflettore in policarbonato.
Driver non incluso, alimentare a 700mA.

Recessed mini LED spotlight.
Aluminum body, polycarbonate reflector.
Driver not included, 700mA in.

°K	Ø(mm)	Øcut(mm)	CRI	Watt	Lumen	Emit °	Current	IP grade	Cod.
3000°K	22	16	>90	2,00	140	36°	700mA	IP44	P7022WW
4000°K	22	16	>90	2,00	160	36°	700mA	IP44	P7022NW

P7027

Incasso / Recessed

Faretto downlight / Downlight

Mini - Residential series

Finiture / Finishes

- Acciaio inox / Stainless steel

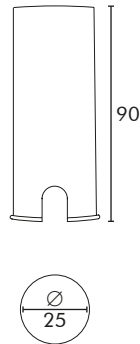
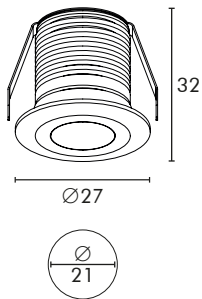

P7027 — Mini - Residential series

Faretto LED mini da incasso, luce spot.
Corpo in acciaio inox, lente in policarbonato UGR<16.
Driver non incluso, alimentare a 24V.

Recessed mini LED spotlight.
Stainless steel body, UGR<16 polycarbonate lens.
Driver not included, 24V in.

°K	Ø(mm)	Øcut(mm)	CRI	Watt	Lumen	Emit °	Current	IP grade	Cod.
3000°K	27	21	>90	1,00	70	36°	24V	IP67	P7027WW
4000°K	27	21	>90	1,00	80	36°	24V	IP67	P7027NW

P7055

Incasso / Recessed

Faretto downlight / Downlight

Mini - Residential series

Finiture / Finishes

- Bianco / White
- RAL (su richiesta) / RAL (upon request)

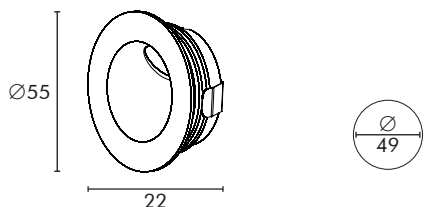

P7055 — Mini - Residential series

Faretto LED mini da incasso, luce spot.
Corpo in alluminio, riflettore in policarbonato.
Driver non incluso, alimentare a 350mA.

Recessed mini LED spotlight.
Aluminum body, polycarbonate reflector.
Driver not included, 350mA in.

°K	Ø(mm)	Øcut(mm)	CRI	Watt	Lumen	Emit °	Current	IP grade	Cod.
3000°K	55	49	>90	1,00	70	36°	350mA	IP54	P7055WW
4000°K	55	49	>90	1,00	80	36°	350mA	IP54	P7055NW

E7066

Incasso / Recessed

Faretto downlight / Downlight

Mini - Residential series

Finiture / Finishes

● Acciaio inox / Stainless steel

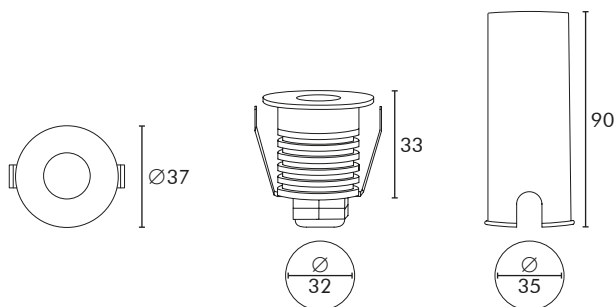

E7066 — Mini - Residential series

Faretto LED mini da incasso, luce spot.
Corpo in acciaio inox, lente in policarbonato.
Driver non incluso, alimentare a 700mA.
Ideale anche per installazione in interramento.

Recessed mini LED spotlight.
Stainless steel body, polycarbonate lens.
Driver not included, 700mA in.
Also ideal for inground installation.

°K	Ø(mm)	Øcut(mm)	CRI	Watt	Lumen	Emit °	Current	IP grade	Cod.
3000°K	37	32	>80	2,00	160	36°	700mA	IP67	E7066WW
4000°K	37	32	>80	2,00	160	36°	700mA	IP67	E7066NW

I7243

Faretto downlight / Downlight

Incasso / Recessed

Mini - Residential series



Finiture / Finishes

- Bianco / White
- RAL (su richiesta) / RAL (upon request)

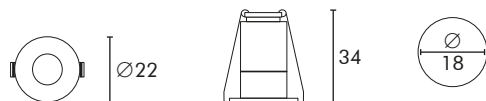

I7243 — Mini - Residential series

Faretto LED orientabile mini da incasso, luce spot.
Corpo in alluminio, lente in policarbonato.
Driver Eaglerise incluso.

Recessed adjustable mini LED spotlight.
Aluminum body, polycarbonate lens.
Eaglerise driver included.

°K	Ø(mm)	Øcut(mm)	CRI	Watt	Lumen	Emit °	Current	IP grade	Cod.
3000°K	22	18	>90	2,00	190	36°	700mA	IP20	I7243WW
4000°K	22	18	>90	2,00	200	36°	700mA	IP20	I7243NW

I7283

Incasso / Recessed

Faretto downlight / Downlight

Mini - Residential series



Finiture / Finishes

- Bianco / White
- RAL (su richiesta) / RAL (upon request)



I7283 — Mini - Residential series

Faretto LED mini da incasso, luce spot.
Corpo in alluminio, lente in policarbonato.
Driver Eaglerise incluso.

Recessed mini LED spotlight.
Aluminum body, polycarbonate lens.
Eaglerise driver included.

°K	Ø(mm)	Øcut(mm)	CRI	Watt	Lumen	Emit °	Current	IP grade	Cod.
3000°K	30	27	>90	3,50	330	24°	350mA	IP20	I7283WW
4000°K	30	27	>90	3,50	350	24°	350mA	IP20	I7283NW

I7253

Incasso / Recessed

Faretto downlight / Downlight

Mini - Residential series



Finiture / Finishes

- Bianco / White
- RAL (su richiesta) / RAL (upon request)



I7253 — Mini - Residential series

Faretto LED mini da incasso, luce spot.
Corpo in alluminio, lente in policarbonato.
Driver Eaglerise incluso.

Recessed mini LED spotlight.
Aluminum body, polycarbonate lens.
Eaglerise driver included.

°K	Ø(mm)	Øcut(mm)	CRI	Watt	Lumen	Emit °	Current	IP grade	Cod.
3000°K	40	35	>90	4,50	300	38°	700mA	IP20	I7253WW
4000°K	40	35	>90	4,50	330	38°	700mA	IP20	I7253NW

I7263/I7363

Faretto downlight / Downlight

Incasso / Recessed

Mini - Residential series



Finiture / Finishes

- Bianco / White
- Nero / Black
- RAL (su richiesta) / RAL (upon request)

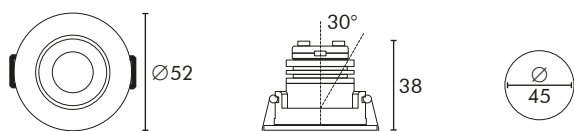

I7263/I7363 — Mini - Residential series

Faretto LED orientabile mini da incasso, luce spot.
Corpo in alluminio, lente in policarbonato.
Driver Eaglerise incluso.

Recessed adjustable mini LED spotlight.
Aluminum body, polycarbonate lens.
Eaglerise driver included.

°K	Ø(mm)	Øcut(mm)	CRI	Watt	Lumen	Emit °	Current	IP grade	Finish	Cod.
3000°K	52	45	>90	4,50	300	38°	700mA	IP20	○	I7263WW
	52	45	>90	4,50	300	38°	700mA	IP20	●	I7363WW
4000°K	52	45	>90	4,50	330	38°	700mA	IP20	○	I7263NW
	52	45	>90	4,50	330	38°	700mA	IP20	●	I7363NW

I7273

Incasso / Recessed

Faretto downlight / Downlight

Mini - Residential series

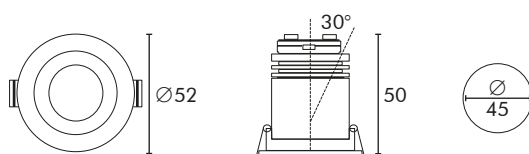

Finiture / Finishes

- Bianco / White
- RAL (su richiesta) / RAL (upon request)

I7273 — Mini - Residential series

Faretto LED orientabile mini da incasso, luce spot.
Corpo in alluminio, lente in policarbonato.
Driver Eaglerise incluso.

Recessed adjustable mini LED spotlight.
Aluminum body, polycarbonate lens.
Eaglerise driver included.

°K	Ø(mm)	Øcut(mm)	CRI	Watt	Lumen	Emit °	Current	IP grade	Cod.
3000°K	52	45	>90	4,50	300	38°	700mA	IP20	I7273WW
4000°K	52	45	>90	4,50	330	38°	700mA	IP20	I7273NW

I1406/I1412

Faretto downlight / Downlight

Incasso / Recessed

Mini - Residential series



Finiture / Finishes

- Bianco / White
- RAL (su richiesta) / RAL (upon request)

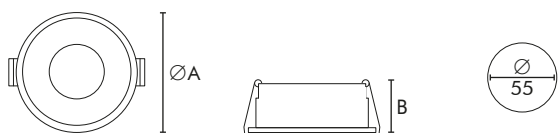

I1406/I1412 — Mini - Residential series

Faretto LED mini da incasso, luce spot.
Corpo in alluminio, lente in policarbonato.
Driver Eaglerise incluso.

Recessed mini LED spotlight.
Aluminum body, polycarbonate lens.
Eaglerise driver included.

°K	dim. ØAxB(mm)	Øcut(mm)	CRI	Watt	Lumen	Emit °	Current	IP grade	Cod.
3000°K	62x25	55	>90	6,00	570	36°	150mA	IP20	I1406WW
	83x31	75	>90	12,00	1140	36°	300mA	IP20	I1412WW
4000°K	62x25	55	>90	6,00	600	36°	150mA	IP20	I1406NW
	83x31	75	>90	12,00	1200	36°	300mA	IP20	I1412NW

H2015/H2215

Faretto downlight / Downlight

Incasso / Recessed

Advance - Residential series

Finiture / Finishes

- Bianco / White
- RAL (su richiesta) / RAL (upon request)



H2015



H2215

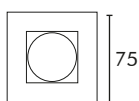
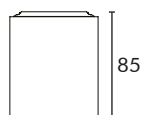

H2015/H2215 — Advance - Residential series

Faretto LED a superficie da soffitto, luce spot.
Riflettore con finitura titanio.
Driver Eaglerise incluso.

Ceiling surface LED spotlight.
Reflector with titanium finish.
Eaglerise driver included.

°K	dim(mm)	CRI	Watt	Lumen	Emit °	Current	Cod.
3000°K	Ø75	>90	15,0	1350	36°	350mA	H2015WW
	75x75	>90	15,0	1350	36°	350mA	H2215WW
4000°K	Ø75	>90	15,0	1425	36°	350mA	H2015NW
	75x75	>90	15,0	1425	36°	350mA	H2215NW

H1118

Incasso / Recessed

Faretto downlight / Downlight

Advance - Residential series

Finiture / Finishes

Bianco / White

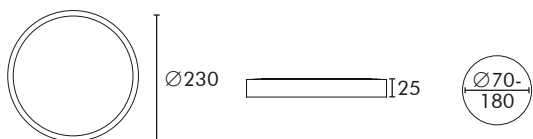

H1118 — Advance - Residential series

Faretto LED da superficie a basso profilo, luce diffusa. Montaggio a staffa o con molle.
Temperatura della luce e potenza regolabili tramite interruttori posti sul retro del corpo illuminante.
Driver integrato.

Low profile LED surface light. Bracket or springs mounting. Light temperature and power adjustable by means of two switches located on the back of the lighting fixture.
Integrated driver.

°K	Ø(mm)	h (mm)	CRI	Watt	Lumen	Emit °	Cod.
- 3000°K - 4000°K - 5500°K	230	25	>80	9,00 - 12,00 - 18,00	1620	110°	H1118ADJ

I390x

Incasso / Recessed

Faretto downlight / Downlight

Advance - Residential series

Finiture / Finishes

Bianco / White

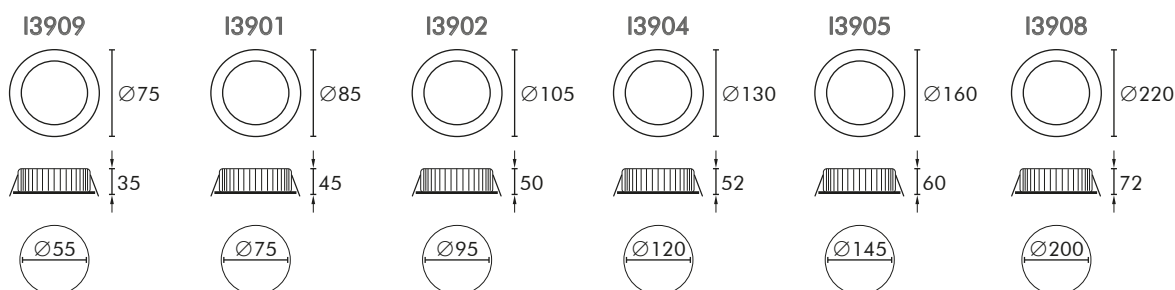

I390x — Advance - Residential series

Faretto LED da incasso, luce spot.
Alta affidabilità, chip cob, lente in policarbonato.
Basso grado di abbagliamento.
Driver Lifud incluso.

Recessed LED spotlight.
High reliability, cob chip, polycarbonate lens.
Low glare.
Lifud driver included.

°K	Ø(mm)	Øcut(mm)	CRI	Watt	Lumen	Emit °	Cod.
3000°K	75	55	>80	5,00	500	36°	I3909WW
	85	75	>80	7,00	700	36°	I3901WW
	105	95	>80	12,00	1200	36°	I3902WW
	130	120	>80	15,00	1500	36°	I3904WW
	160	145	>80	20,00	2000	36°	I3905WW
	220	200	>80	35,00	3500	36°	I3908WW
4000°K	70	62	>80	5,00	500	36°	I3909NW
	87	75	>80	7,00	700	36°	I3901NW
	110	95	>80	12,00	1200	36°	I3902NW
	140	125	>80	15,00	1500	36°	I3904NW
	160	140	>80	20,00	2000	36°	I3905NW
	180	160	>80	35,00	3500	36°	I3908NW

I290x

Incasso / Recessed

Faretto downlight / Downlight

Advance - Residential series



Finiture / Finishes

- Bianco / White
- RAL (su richiesta) / RAL (upon request)

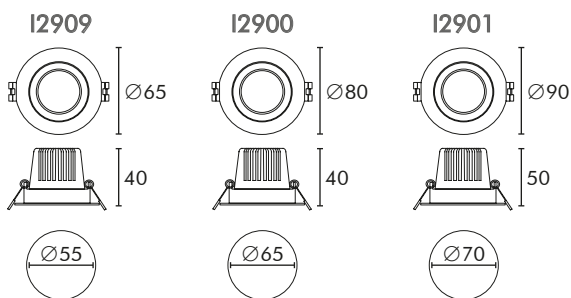

I290x — Advance - Residential series

Faretto LED da incasso orientabile, luce spot.
Alta affidabilità, chip cob.
Driver Lifud incluso.

Adjustable recessed LED spotlight.
High reliability, cob chip.
Lifud driver included.

°K	Ø(mm)	Øcut(mm)	CRI	Watt	Lumen	Emit °	Cod.
3000°K	65	55	>80	3,00	300	36°	I2909WW
	80	65	>80	6,00	600	36°	I2900WW
	90	70	>80	12,00	1200	36°	I2901WW
4000°K	65	55	>80	3,00	300	36°	I2909NW
	80	65	>80	6,00	600	36°	I2900NW
	90	70	>80	12,00	1200	36°	I2901NW

Retail Series

Fari da negozio / Retail lighting

Superficie, incasso e sospensione / Surface, recessed and suspension

Retail series

Spot

Faretto downlight / Downlight



I1359



I1360



I1361



H1615



H1640

Track

Binario trifase / 3-phase track



T_322



T_323

Tracklight

Fari per binario trifase / 3-phase track lights



R4_81



R4_83



R4_85



R4_25



R4_35



R3_85



R0060



R0150



R472

Retail series

Fari da negozio / Retail lighting

Superficie, incasso e sospensione / Surface, recessed and suspension

Retail series



I13xx

Faretto downlight / Downlight

Incasso / Recessed

Spot - Retail series



Finiture / Finishes

- Bianco / White

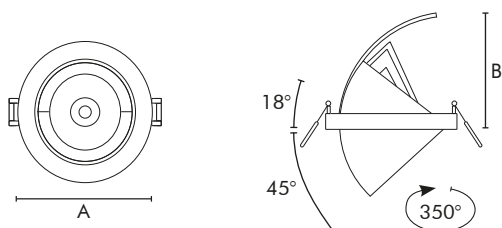

I13xx — Spot - Retail series

Faro led da incasso, ideale per negozi.
Elevata resa cromatica.
Dissipatore in alluminio performante.
Driver Eaglerise incluso.

Recessed LED shop spotlight.
High color rendering.
High performance aluminum heatsink.
Eaglerise driver included.

°K	dim A-B(mm)	cut(mm)	CRI	Watt	Lumen	Emit °	Current	Cod.
3000°K	Ø105-82	Ø90	>90	15,00	1420	40°	350mA	I1359WW
	Ø158-130	Ø145	>90	33,00	2900	40°	800mA	I1360WW
	Ø188-159	Ø170	>90	40,00	3800	40°	900mA	I1361WW
4000°K	Ø105-82	Ø90	>90	15,00	1490	40°	350mA	I1359NW
	Ø158-130	Ø145	>90	33,00	3000	40°	800mA	I1360NW
	Ø188-159	Ø170	>90	40,00	4000	40°	900mA	I1361NW

H16xx

Faretto downlight / Downlight

Incasso / Recessed

Spot - Retail series



Finiture / Finishes

- Bianco / White
- RAL (su richiesta) / RAL (upon request)

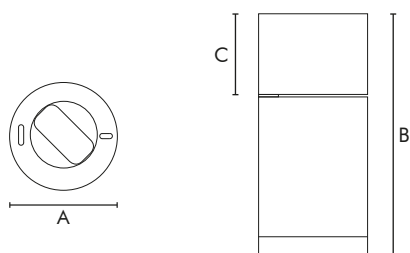

H16xx — Spot - Retail series

Faro led da parete, ideale per negozi.
Elevata resa cromatica.
Driver Eaglerise incluso.

LED wall light, ideal for shops.
High color rendering.
Eaglerise driver included.

°K	dim A-B-C(mm)	CRI	Watt	Lumen	Emit °	Cod.
3000°K	Ø54-152-35	>90	15,00	1360	38°	H1615WW
	Ø90-195-45	>90	40,00	3600	38°	H1640WW
4000°K	Ø54-152-35	>90	15,00	1425	38°	H1615NW
	Ø90-195-45	>90	40,00	3800	38°	H1640NW
- 3000°K - 4000°K - 5500°K	Ø54-152-35	>90	15,00	1360	38°	H1615ADJ

Track superficie / surface

Per fari led track / For led track lights

Binario trifase / 3-phase Track

Track - Retail series

Finiture / Finishes

○ Bianco / White

● Nero / Black

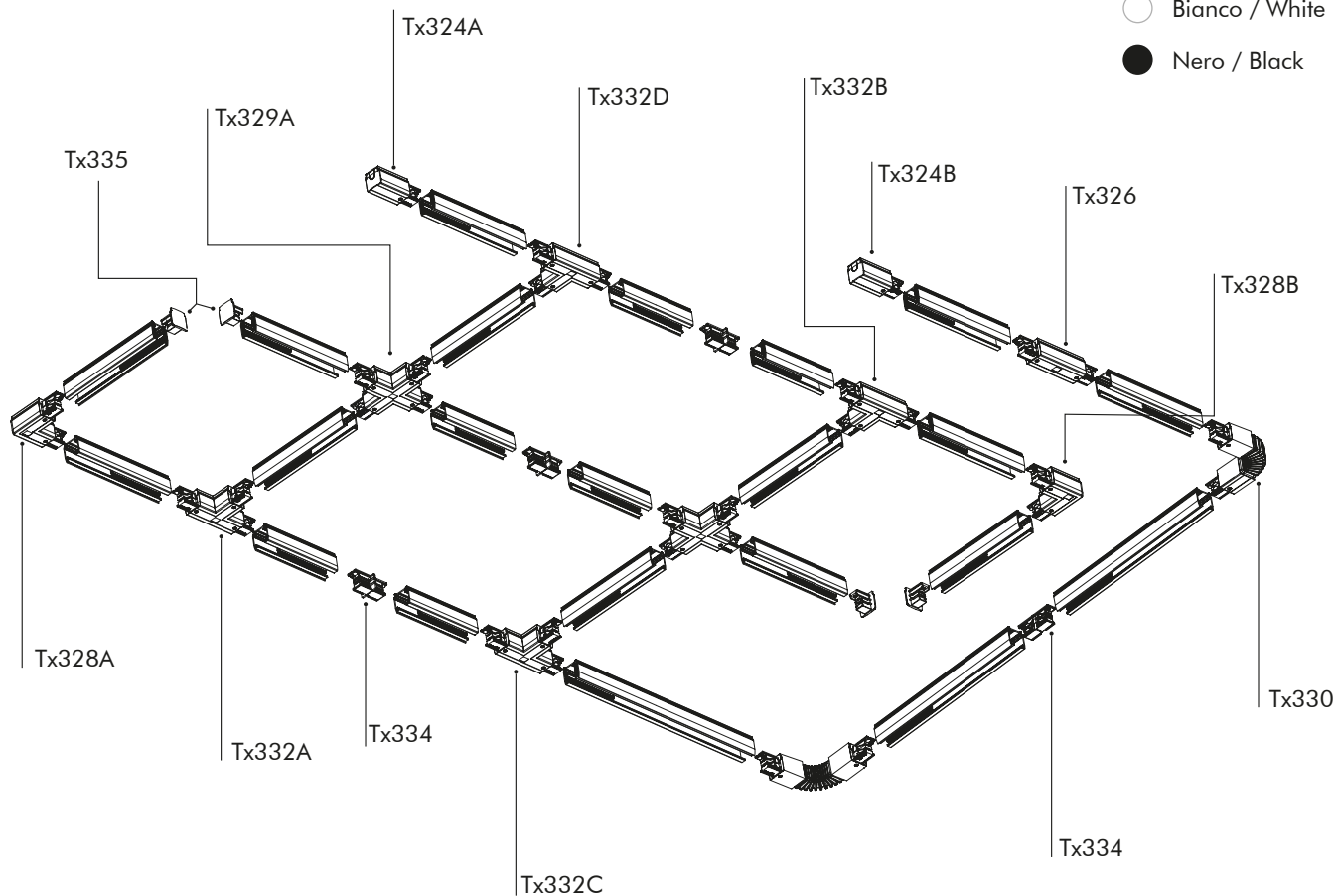

TRACK —————● Track series

Binario elettrificato a 3 accensioni, in alluminio.
 Per installazione a superficie.
 Su richiesta disponibile anche per installazione a incasso.
 Compatibile con tutti i fari della serie Track Pro-Light.

Aluminium 3 phase track.
 For surface installation.
 Recessed installation version available upon request.
 Compatible with all the Pro-Light tracklights.

Length (mm)	Finish	Cod.
1000	○	T0321
2000	○	T0322
3000	○	T0323
1000	●	T1321
2000	●	T1322
3000	●	T1323



Track superficie / surface

Accessori binario / Track accessories

Per fari led track / For led track lights

Track - Retail series

Finish	Cod.	
<input type="radio"/>	T0324	Tx324 Connettore alimentazione / Power connector
<input checked="" type="radio"/>	T1324	<p>Tx324A sx/left Tx324B dx/right</p>
<input type="radio"/>	T0326	Tx326 Connettore esterno dritto / Straight external connector
<input checked="" type="radio"/>	T1326	
<input type="radio"/>	T0330	Tx330 Connettore esterno flessibile / Flexible external connector
<input checked="" type="radio"/>	T1330	
<input type="radio"/>	T0334	Tx334 Connettore interno dritto / Straight internal connector
<input checked="" type="radio"/>	T1334	
<input type="radio"/>	T0328	Tx328 "L"
<input checked="" type="radio"/>	T1328	<p>Tx328A sx/left Tx328B dx/right</p>
<input type="radio"/>	T0329	Tx329 "X"
<input checked="" type="radio"/>	T1329	
<input type="radio"/>	T0332	Tx332 "T"
<input checked="" type="radio"/>	T1332	<p>Tx332A sx/left 1 Tx332B sx/left 2 Tx332C dx/right 1 Tx332D dx/right 2</p>
<input type="radio"/>	T0335	Tx335 Tappo / End cap
<input checked="" type="radio"/>	T1335	
<input type="radio"/>	T0337	Tx337 Kit per sospensione / Suspension kit
<input checked="" type="radio"/>	T1337	
<input type="radio"/>	T0338	Tx338 Kit per montaggio a superficie / Surface mounting kit
<input checked="" type="radio"/>	T1338	
<input type="radio"/>	T0180	Tx180 Adattatore universale 3-fase / Universal 3-phase adapter
<input checked="" type="radio"/>	T1180	

R4081 - R4181

Binario / Track

Faro track / Track light

Tracklight - Retail series



Finiture / Finishes

○ Bianco / White

● Nero / Black

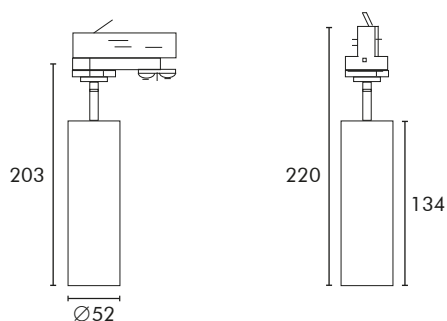

R4081/R4181 — Tracklight - Retail series

Faro led track orientabile, per binario elettrificato a 3 accensioni. Lente da 38° UGR<19 inclusa, ampiezza angolo di emissione personalizzabile con lenti custom.

Adjustable led track light, for electrified 3 phase track. 38° UGR<19 lens included, emission angle width customizable with custom lenses.

°K	Ø(mm)	UGR	CRI	Watt	Lumen	Emit °	Current	Finish	Cod.
3000°K	52	<19	>90	12,00	1104	38°	300mA	○	R4081WW
	52	<19	>90	12,00	1180	38°	300mA	●	R4181WW
4000°K	52	<19	>90	12,00	1104	38°	300mA	○	R4081NW
	52	<19	>90	12,00	1180	38°	300mA	●	R4181NW

Accessori / Accessories

Cod.	Descr.
I381	Lente 15° / 15° lens
I383	Lente 24° / 24° lens
I387	Lente 55° / 55° lens
I3-H	Diffusore UGR<13 / UGR<13 diffuser

R4083 - R4183

Binario / Track

Faro track / Track light

Tracklight - Retail series



Finiture / Finishes

○ Bianco / White

● Nero / Black

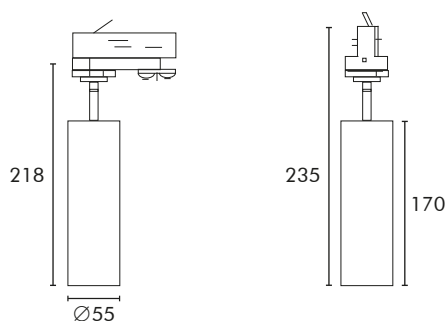

R4083/R4183 — Tracklight - Retail series

Faro led track orientabile, per binario elettrificato a 3 accensioni. Lente da 38° UGR<19 inclusa, ampiezza angolo di emissione personalizzabile con lenti custom.

Adjustable led track light, for electrified 3 phase track. 38° UGR<19 lens included, emission angle width customizable with custom lenses.

°K	Ø(mm)	UGR	CRI	Watt	Lumen	Emit °	Current	Finish	Cod.
3000°K	55	<19	>90	20,00	1840	38°	500mA	○	R4083WW
	55	<19	>90	20,00	1960	38°	500mA	●	R4183WW
4000°K	55	<19	>90	20,00	1840	38°	500mA	○	R4083NW
	55	<19	>90	20,00	1960	38°	500mA	●	R4183NW

Accessori / Accessories

Cod.	Descr.
I381	Lente 15° / 15° lens
I383	Lente 24° / 24° lens
I387	Lente 55° / 55° lens
I3-H	Diffusore UGR<13 / UGR<13 diffuser

R4085 - R4185

Binario / Track

Faro track / Track light

Tracklight - Retail series



Finiture / Finishes

○ Bianco / White

● Nero / Black

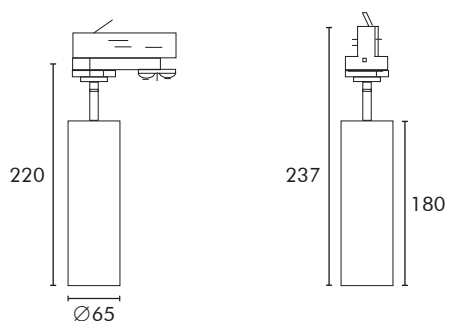

R4085/R4185 — Tracklight - Retail series

Faro led track orientabile, per binario elettrificato a 3 accensioni. Lente da 38° UGR<19 inclusa, ampiezza angolo di emissione personalizzabile con lenti custom.

Adjustable led track light, for electrified 3 phase track. 38° UGR<19 lens included, emission angle width customizable with custom lenses.

°K	Ø(mm)	UGR	CRI	Watt	Lumen	Emit °	Current	Finish	Cod.
3000°K	65	<19	>90	30,00	2760	38°	800mA	○	R4085WW
	65	<19	>90	30,00	2940	38°	800mA	●	R4185WW
4000°K	65	<19	>90	30,00	2760	38°	800mA	○	R4085NW
	65	<19	>90	30,00	2940	38°	800mA	●	R4185NW

Accessori / Accessories

Cod.	Descr.
I062	Lente 15° / 15° lens
I066	Lente 55° / 55° lens

R4425 - R4525

Binario / Track

Faro track / Track light

Tracklight - Retail series



Finiture / Finishes

○ Bianco / White

● Nero / Black

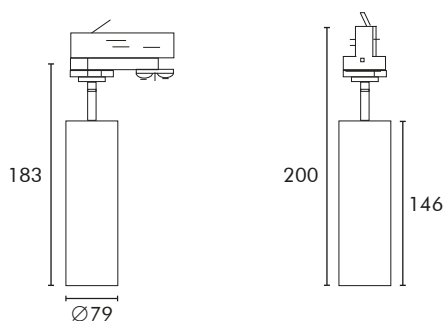

R4425/R4525 — Tracklight - Retail series

Faretto a binario led orientabile, per binario elettrificato trifase. Lente 38° UGR<19. Temperatura della luce regolabile tramite interruttore posto sul retro del corpo illuminante.

Adjustable led track light, for electrified 3 phase track. 38° UGR<19 lens. Light temperature adjustable by means of a switch located on the back of the lighting fixture.

°K	Ø(mm)	UGR	CRI	Watt	Lumen	Emit °	Finish	Cod.
- 3000°K	79	<19	>90	25,00	2280	38°	○	R4425ADJ
- 4000°K								
- 5500°K	79	<19	>90	25,00	2280	38°	●	R4525ADJ

R4435 - R4535

Binario / Track

Faro track / Track light

Tracklight - Retail series



Finiture / Finishes

○ Bianco / White

● Nero / Black

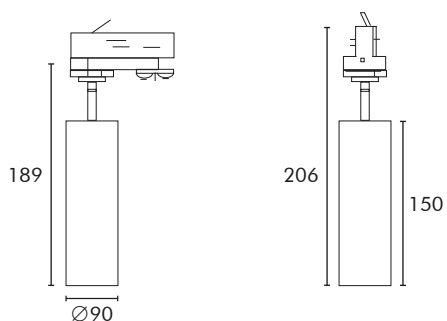

R4435/R4535 — Tracklight - Retail series

Faretto a binario led orientabile, per binario elettrificato trifase. Lente 38° UGR<19. Temperatura della luce regolabile tramite interruttore posto sul retro del corpo illuminante.

Adjustable led track light, for electrified 3 phase track. 38° UGR<19 lens. Light temperature adjustable by means of a switch located on the back of the lighting fixture.

°K	Ø(mm)	UGR	CRI	Watt	Lumen	Emit °	Finish	Cod.
- 3000°K	90	<19	>90	35,00	3190	38°	○	R4435ADJ
- 4000°K	90	<19	>90	35,00	3190	38°	●	R4535ADJ
- 5500°K								

R3085 - R3185

Binario / Track

Faro track / Track light

Tracklight - Retail series



Finiture / Finishes

○ Bianco / White

● Nero / Black

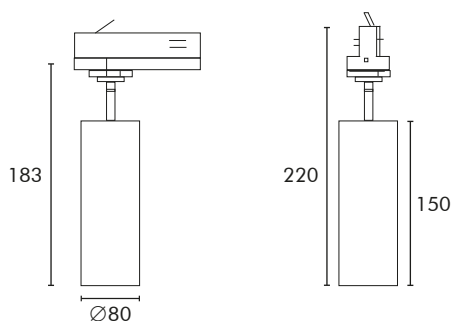

R3085/R3185 —● Tracklight - Retail series

Faretto a binario led orientabile, per binario elettrificato trifase.
Lente 38° UGR<19.
Driver in-track che va ad integrarsi nel binario.

Adjustable led track light, for electrified 3 phase track.
38° UGR<19 lens.
In-track driver.

°K	Ø(mm)	UGR	CRI	Watt	Lumen	Emit °	Finish	Cod.
3000°K	80	<19	>90	30,00	2700	38°	○	R3085WW
	80	<19	>90	30,00	2700	38°	●	R3185WW
4000°K	80	<19	>90	30,00	2700	38°	○	R3085NW
	80	<19	>90	30,00	2700	38°	●	R3185NW

R0060 - R0150

Binario / Track

Faro track / Track light

Tracklight - Retail series



Finiture / Finishes

Bianco / White

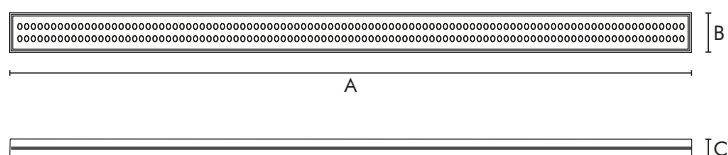

R0060/R0150 — Tracklight - Retail series

Faro lineare a binario led, per binario elettrificato trifase. Lente UGR<19 a 60° oppure doppia asimmetrica 30°/30°, per illuminazione scaffali. Potenza regolabile tramite interruttore posto sul retro del corpo illuminante.

Linear led track light, for electrified 3 phase track. 60° UGR<19 lens or double asymmetrical 30°/30°, for shelf lighting. Power adjustable with a switch located on the back of the lighting fixture.

°K	dim A-B-C(mm)	UGR	CRI	Watt	Lumen	Emit °	Cod.
4000°K	600-62-15	<19	>90	20-18-16-14	3190	60°-30°/30°	R0060NW
	1500-62-15	<19	>90	50-45-40-35	3190	60°-30°/30°	R0150NW

R472

Binario / Track

Faro track / Track light

Tracklight - Retail series

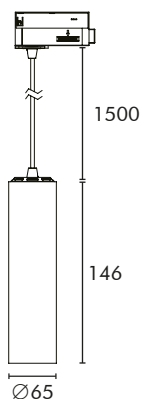

Finiture / Finishes

- Bianco / White
- RAL (su richiesta) / RAL (upon request)

R472 — Tracklight - Retail series

Faretto a binario led a sospensione, per binario elettrificato trifase. Lente 38° UGR<19.

Suspended led track spotlight, for electrified 3 phase track. 38° UGR<19 lens.

°K	Ø(mm)	UGR	CRI	Watt	Lumen	Emit °	Current	Cod.
2700°K	65	<19	>90	9,00	829	38°	200mA	R472HW
3000°K	65	<19	>90	9,00	878	38°	200mA	R472WW
4000°K	65	<19	>90	9,00	932	38°	200mA	R472WW

Office Series

Fari da ufficio / Office lighting

Superficie, incasso e sospensione / Surface, recessed and suspension

Office series

Panel

Pannello led / Led panel



U6545



U6550



U6650

Linear System

Luce lineare / Linear light



S50



S75

Office series

Fari da ufficio / Office lighting

Superficie, incasso e sospensione / Surface, recessed and suspension

Office series

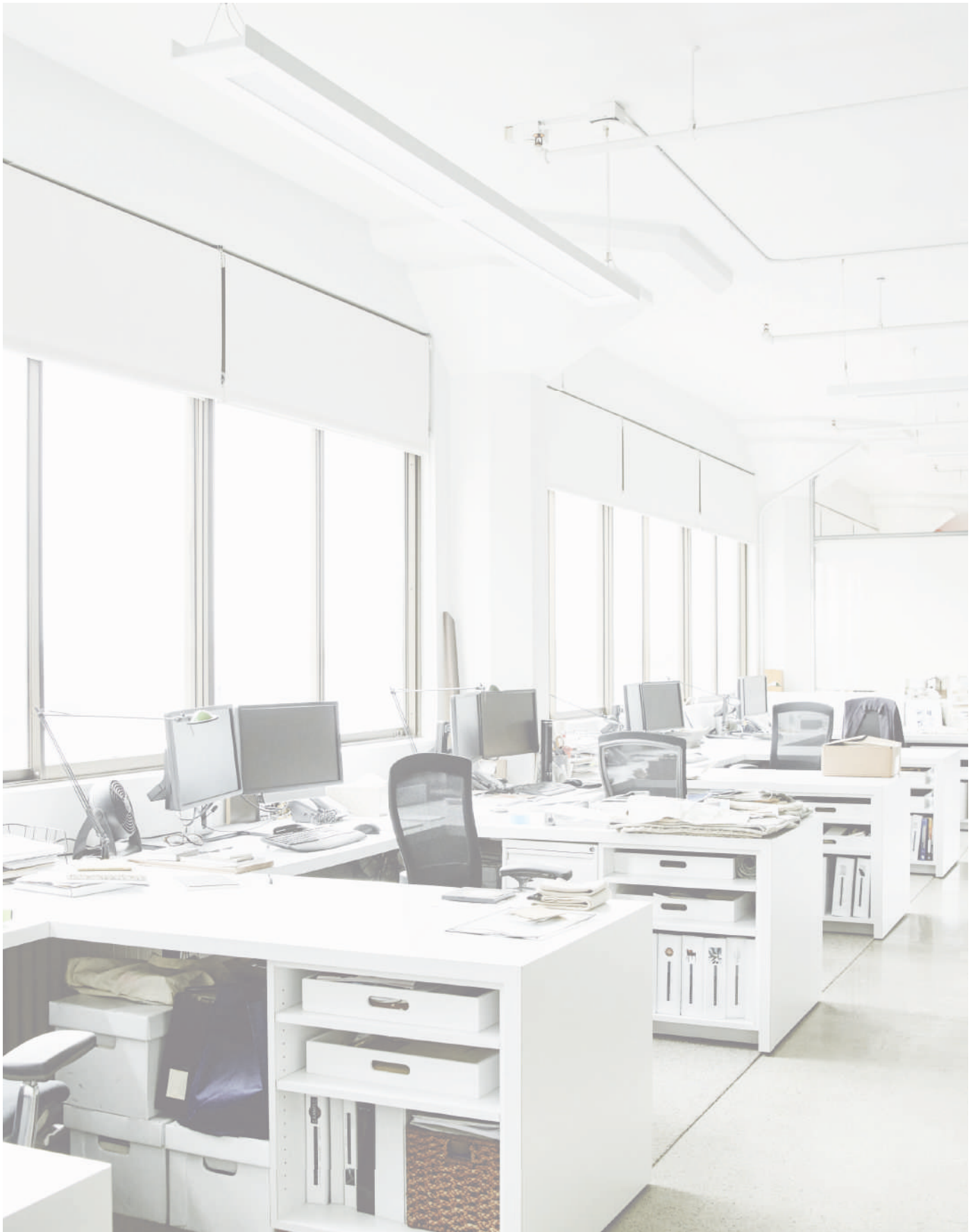

U6545

Pannello Led / Led Panel

Incasso, superficie, sospensione / Recessed, surface, suspension

Panel - Office series

Finiture / Finishes

Bianco / White

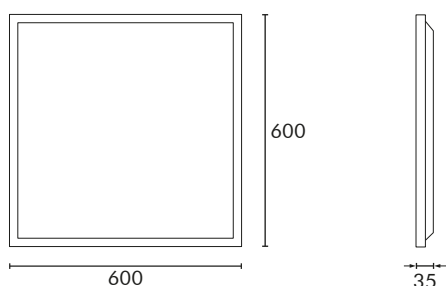

U6545 — Panel - Office series

Pannello LED backlit, luce diffusa.
Schermo satinato con UGR<19.
Driver flicker-free ad alta efficienza incluso.

Backlit LED panel, diffused light.
Satin screen with UGR<19.
High efficiency flicker-free driver included.

°K	dim(mm)	cut(mm)	CRI	Watt	Lumen	Emit °	Current	Cod.
3000°K	600x600	597x597	>80	40,00	3500	120°	350mA	U6545WW
4000°K	600x600	597x597	>80	40,00	3600	120°	350mA	U6545NW

Accessori / Accessories

Cod.	Descr.
U6011	Kit mont. sospensione / Suspension kit
U6013	Frame mont. parete / Wall mount frame
U6015	Molle mont. incasso / Springs for recessed mounting

U6550

Pannello Led / Led Panel

Incasso, superficie, sospensione / Recessed, surface, suspension

Panel - Office series



Finiture / Finishes

Bianco / White

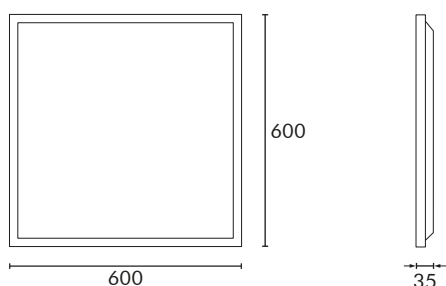

Microprismatic screen UGR<16

U6550 Panel - Office series

Pannello LED backlit, luce diffusa.
Schermo microprismatico con UGR<16.
Driver flicker-free ad alta efficienza incluso.

Backlit LED panel, diffused light.
Microprismatic screen with UGR<16.
High efficiency flicker-free driver included.

°K	dim(mm)	cut(mm)	CRI	Watt	Lumen	Emit °	Current	Cod.
4000°K	600x600	597x597	>80	40,00	4000	120°	350mA	U6550NW

Accessori / Accessories

Cod.	Descr.
U6011	Kit mont. sospensione / Suspension kit
U6013	Frame mont. parete / Wall mount frame
U6015	Molle mont. incasso / Springs for recessed mounting

U6650

Pannello Led / Led Panel

Incasso, superficie, sospensione / Recessed, surface, suspension

Panel - Office series

Finiture / Finishes

Bianco / White

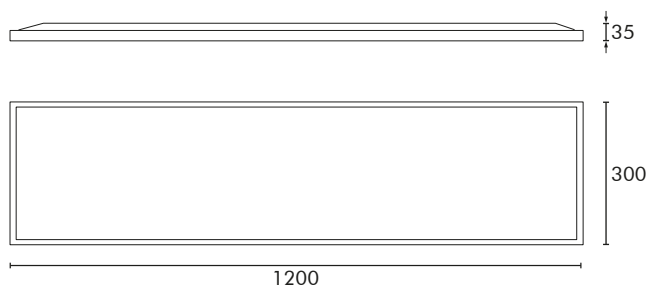

Microprismatic screen UGR<16

U6650 — Panel - Office series

Pannello LED backlit, luce diffusa.
Schermo microprismatico con UGR<16.
Driver flicker-free ad alta efficienza incluso.

Backlit LED panel, diffused light.
Microprismatic screen with UGR<16.
High efficiency flicker-free driver included.

°K	dim(mm)	cut(mm)	CRI	Watt	Lumen	Emit °	Current	Cod.
4000°K	1200x300	1200x300	>80	40,00	4000	120°	350mA	U6650NW

Accessori / Accessories

Cod.	Descr.
U6011	Kit mont. sospensione / Suspension kit
U6014	Frame mont. parete / Wall mount frame
U6015	Molle mont. incasso / Springs for recessed mounting



Linear System

Sospensione / Suspension

Luce lineare / Linear light

Linear system - Office series

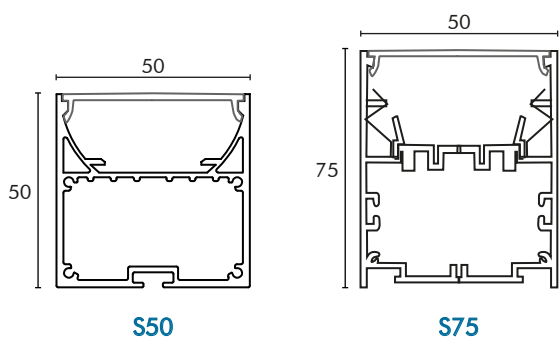

Finiture
Finishes

- Aluminium ●
- RAL

Fonte di luce
Light source

- Plus 2835
- Cob Cri>90
- Ultra 2216 Cri>90
- Over 2835 150lm/w ●
- Special rgbw/dual

Temperatura colore
Color temperature

- 2700°K
- 3000°K ●
- 4000°K ●
- 5000°K
- 6000°K

● Configurazioni standard
Standard configurations

S50/S75 ———— ● Linear system - Office series

Corpo illuminante lineare, per installazione a sospensione o a parete. Driver ad alta efficienza, elevata resa cromatica.
Corpo in alluminio pressofuso.
Schermo in polcarbonato opale.
Codici prodotto su richiesta.

Linear luminaire, for suspended or wall installation.
High efficiency driver, high color rendering.
Die-cast aluminum body.
Opal polycarbonate screen.
Item code upon request.

Cod.	Lenght	Driver	°K	Watt	Finish	Lumen	Emit °	IP grade
S50 S75	Fino a/Up to 2000mm	On/off DALI / push RF	2700-6000 RGB	Fino a/Up to 24 W/m	● Alu ● RAL	Fino a/Up to 150 lm/W	120°	IP40

Linear System

Incasso / Recessed

Luce lineare / Linear light

Linear system - Office series



S75



S75 - Montaggio a Sospensione / Suspension mounting



S75 - Montaggio a Plafone / Wall mounted

Industrial Series

Fari uso industriale / Industrial use lighting

Superficie e sospensione / Surface and suspension

Industrial series

High bay

Plafone led / High bay



M1410

M1415

M1420

Plafò

Plafoniera led / Led batten



U3062

U3122

U3152

Flood

Proiettore led / Led flood light



B2020

B2030

B2050

B2100

B2150

B2200

B3050

B3100

B3150

B3200

Industrial series

Superficie / Surface

Faretto da esterno / Outdoor spotlight

Industrial series



M14xx

Sospensione / Suspension

Plafone Led / High bay

High bay - Industrial series

Finiture / Finishes

● Nero / Black

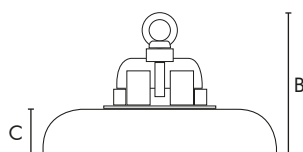
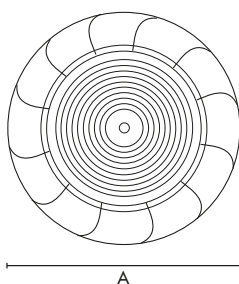

M14xx High bay - Industrial series

Plafone LED multichip IP65, ad elevate prestazioni.
Lenti individuali, alta efficienza
Driver esterno Flicker-Free incluso.

High performance IP65 multichip LED high bay light.
Individual lenses, high efficiency.
Flicker-Free external driver included.

°K	Ø(mm)	dim A-B-C(mm)	CRI	Watt	Lumen	Emit °	IP grade	V in	Cod.
4000°K	280	280-167-52	>70	100,00	17000	90°	IP65	220-240	M1410NW
	320	320-167-52	>70	150,00	25000	90°	IP65	220-240	M1415NW
	350	350-167-52	>70	200,00	34000	90°	IP65	220-240	M1420NW

U3xx2

Superficie / Surface

Plafoniera Led / Led Batten

Plafo - Industrial series

Finiture / Finishes

● Grigio / Grey

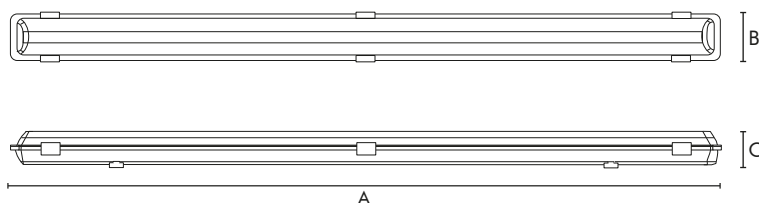

Microprismatic screen UGR<19

U3xx2 —● Plafo - Industrial series

Plafoniera stagna nativa a Led, IP65.
Piastra interna dissipante e PCB in metal core.
Schermo microprismatico con UGR<19.
Driver flicker-free ad alta efficienza incluso.

LED waterproof ceiling light, IP65.
Internal dissipating plate and metal core PCB.
Microprismatic screen with UGR<19.
High efficiency flicker-free driver included.

°K	dim A-B-C(mm)	CRI	Watt	Lumen	Emit °	IP grade	V in	Cod.
4000°K	600-98-74	>80	20,00	2610	130°	IP65	220-240	U3062NW
	1200-98-74	>80	40,00	5170	130°	IP65	220-240	U3122NW
	1500-98-74	>80	50,00	6760	130°	IP65	220-240	U3152NW
6000°K	1500-98-74	>80	50,00	6860	130°	IP65	220-240	U3152CW

Emergenza / Emergency

°K	dim A-B-C(mm)	CRI	Watt	Lumen	Emit °	IP grade	V in	Emergency	Cod.
4000°K	600-98-74	>80	20,00	2610	130°	IP65	220-240	EM Kit	U3062EMNW
	1200-98-74	>80	40,00	5170	130°	IP65	220-240	EM Kit	U3122EMNW
	1500-98-74	>80	50,00	6760	130°	IP65	220-240	EM Kit	U3152EMNW
6000°K	1500-98-74	>80	50,00	6860	130°	IP65	220-240	EM Kit	U3152EMCW

B2xx0

Superficie / Surface

Proiettore Led / Led Flood light

Flood - Industrial series



Finiture / Finishes

● Grigio / Grey

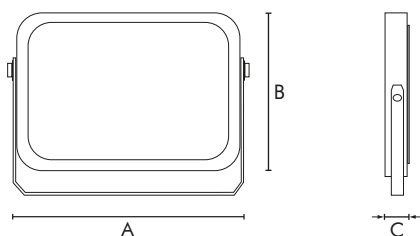

B2xx0 — Flood - Industrial series

Proiettore LED per esterno, IP65.
Corpo di dimensioni compatte, schermo in policarbonato con lenti individuali integrate.
Driver integrato.

LED outdoor floodlight, IP65.
Compact size body, polycarbonate screen with individual lenses integrated.
Integrated driver.

°K	dim A-B-C(mm)	CRI	Watt	Lumen	Emit °	IP grade	V in	Cod.
3000°K	140-104-19	>80	20,00	1880	90°	IP65	220-240	B2020WW
	167-122-24	>80	30,00	2820	90°	IP65	220-240	B2030WW
	213-160-26	>80	50,00	4700	90°	IP65	220-240	B2050WW
	278-210-31	>80	100,00	9400	90°	IP65	220-240	B2100WW
4000°K	140-104-19	>80	20,00	2000	90°	IP65	220-240	B2020NW
	167-122-24	>80	30,00	3000	90°	IP65	220-240	B2030NW
	213-160-26	>80	50,00	5000	90°	IP65	220-240	B2050NW
	278-210-31	>80	100,00	10000	90°	IP65	220-240	B2100NW
	340-250-39	>80	150,00	15000	90°	IP65	220-240	B2150NW
	393-280-41	>80	200,00	20000	90°	IP65	220-240	B2200NW

B3xx0

Superficie / Surface

Proiettore Led / Led Flood light

Flood - Industrial series

Finiture / Finishes

● Nero / Black

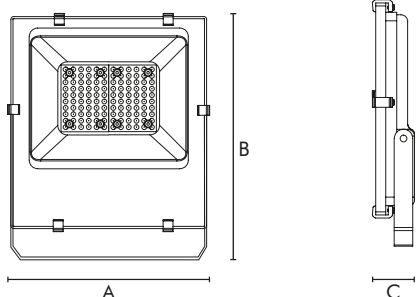

B3xx0 — Flood - Industrial series

Proiettore LED per esterno, IP65.
Alta efficienza e lunga durata nel tempo, driver separato incluso.
Schermo in vetro temperato, fissato con clip in acciaio.

LED outdoor floodlight, IP65.
High efficiency and long lifespan, separated driver included..
Tempered glass screen, fixed with steel clips.

°K	dim A-B-C(mm)	CRI	Watt	Lumen	Emit °	IP grade	V in	Cod.
4000°K	211-281-45	>80	50,00	5500	60°	IP65	220-240	B3050NW
	252-356-50	>80	100,00	11000	60°	IP65	220-240	B3100NW
	322-400-53	>80	150,00	16500	60°	IP65	220-240	B3150NW
	361-457-54	>80	200,00	22000	60°	IP65	220-240	B3200NW

Garden Series

Superficie / Surface

Faretto da esterno / Outdoor spotlight

Garden series

Surface

Faretto da esterno / Outdoor spotlight



D4003



D4007



D4012



D4230

Inground

Faretto da esterno / Outdoor spotlight



E1903



E2003



E1913



E2103



E2013



E2023



E2033



E3107



E3115

Garden series

Superficie / Surface

Faretto da esterno / Outdoor spotlight

Garden series



D40xx

Superficie / Surface

Faretto da esterno / Outdoor spotlight

Surface - Garden series

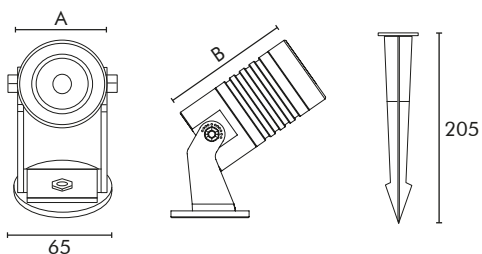

Finiture / Finishes

- Antracite / Anthracite

D40xx — Surface - Garden series

Faretto LED da esterno, IP65.
Corpo in alluminio, diffusore in vetro temperato.
Picchetto in plastica e base in alluminio inclusi.

Outdoor LED spotlight, IP65.
Aluminum body, tempered glass diffuser.
Plastic stake and aluminum base included.

°K	dim A-B(mm)	CRI	Watt	Lumen	Emit °	IP grade	V in	Cod.
3000°K	Ø42-78	>80	3,00	225	30°	IP65	230Vac	D4003WW
	Ø50-88	>80	7,00	525	30°	IP65	230Vac	D4007WW
	Ø68-95	>80	12,00	900	30°	IP65	230Vac	D4012WW
4000°K	Ø42-78	>80	3,00	240	30°	IP65	230Vac	D4003NW
	Ø50-88	>80	7,00	560	30°	IP65	230Vac	D4007NW
	Ø68-95	>80	12,00	960	30°	IP65	230Vac	D4012NW

D4230

Superficie / Surface

Faretto da esterno / Outdoor spotlight

Surface - Garden series

Finiture / Finishes

● Grigio / Grey



D4230 — Surface - Garden series

Faretto LED da esterno, IP65.
Corpo in alluminio, diffusore in vetro temperato.
Picchetto in plastica e base in alluminio inclusi.

Outdoor LED spotlight, IP65.
Aluminum body, tempered glass diffuser.
Plastic stake and aluminum base included.

°K	CRI	Watt	Lumen	Emit °	IP grade	V in	Cod.
3000°K	>80	30,00	2340	30°	IP65	230Vac	D4230WW
4000°K	>80	30,00	2400	30°	IP65	230Vac	D4230NW

E1903/E2003

Interramento / Inground

Faretto da esterno / Outdoor spotlight

Inground - Garden series

Finiture / Finishes

- Acciaio inox / Stainless steel



E1903

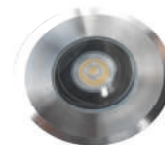

E2003

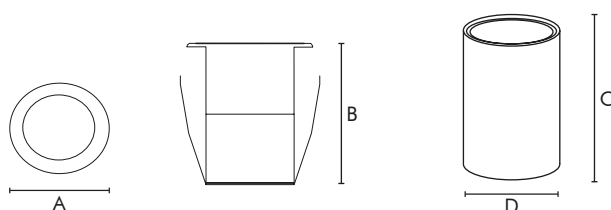

E1903/E2003 —● Inground - Garden series

Faretto LED da interramento, IP67

Corpo interamente in acciaio inox, diffusore in vetro temperato.
Driver non incluso, alimentare a 24V.

IP67 inground LED spotlight.

Stainless steel body, tempered glass diffuser.
Driver not included, 24V in.

°K	dim A-B-C-D(mm)	CRI	Watt	Lumen	Emit °	IP grade	V in	Cod.
3000°K	Ø42-56-70-Ø35	>80	3,00	225	30°	IP67	24V	E1903WW
	Ø62-51-86-Ø53	>80	3,00	225	30°	IP67	24V	E2003WW
4000°K	Ø42-56-70-Ø35	>80	3,00	240	30°	IP67	24V	E1903NW
	Ø62-51-86-Ø53	>80	3,00	240	30°	IP67	24V	E2003NW

E1913/E2103

Superficie / Surface

Faretto da esterno / Outdoor spotlight

Inground - Garden series

Finiture / Finishes

- Acciaio inox / Stainless steel

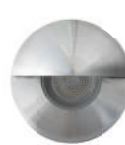

E1913

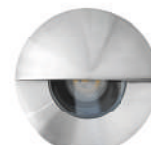

E2103

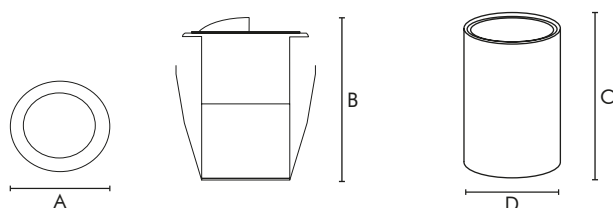

E1913/E2103 —● Inground - Garden series

Faretto LED da interramento, IP67

Corpo interamente in acciaio inox, diffusore in vetro temperato.
Driver non incluso, alimentare a 24V.

IP67 inground LED spotlight.

Stainless steel body, tempered glass diffuser.
Driver not included, 24V in.

°K	dim A-B-C-D(mm)	CRI	Watt	Lumen	Emit °	IP grade	V in	Cod.
3000°K	Ø42-65-70-Ø35	>80	3,00	202	30°	IP67	24V	E1913WW
	Ø62-61-86-Ø53	>80	3,00	202	30°	IP67	24V	E2103WW
4000°K	Ø42-65-70-Ø35	>80	3,00	216	30°	IP67	24V	E1913NW
	Ø62-61-86-Ø53	>80	3,00	216	30°	IP67	24V	E2103NW

E20x3

Faretto da esterno / Outdoor spotlight

Interramento / Inground

Inground - Garden series

Finiture / Finishes

● Acciaio inox / Stainless steel



E2013



E2023

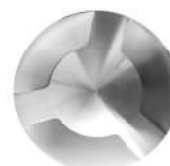

E2033

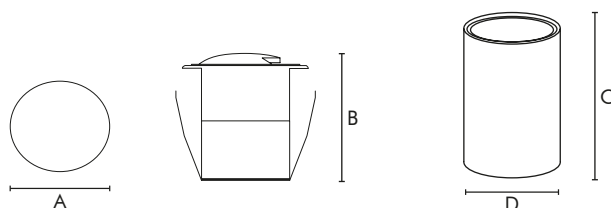

E20x3 — Inground - Garden series

Faretto LED da interramento, IP67
Corpo interamente in acciaio inox, diffusore in vetro temperato.
Driver non incluso, alimentare a 24V.

IP67 inground LED spotlight.
Stainless steel body, tempered glass diffuser.
Driver not included, 24V in.

°K	dim A-B-C-D(mm)	CRI	Watt	Lumen	Emit °	IP grade	V in	Cod.
3000°K	Ø62-61-87-Ø53	>80	3,00	140	30°	IP67	24V	E2013WW
	Ø62-61-87-Ø53	>80	3,00	140	30°	IP67	24V	E2023WW
	Ø62-61-87-Ø53	>80	3,00	140	30°	IP67	24V	E2033WW
4000°K	Ø62-61-87-Ø53	>80	3,00	145	30°	IP67	24V	E2013NW
	Ø62-61-87-Ø53	>80	3,00	145	30°	IP67	24V	E2023NW
	Ø62-61-87-Ø53	>80	3,00	145	30°	IP67	24V	E2033NW

E3107/E3115

Superficie / Surface

Faretto da esterno / Outdoor spotlight

Inground - Garden series

Finiture / Finishes

- Acciaio inox / Stainless steel



E3107

E3115

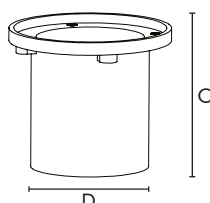
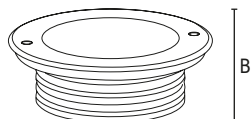
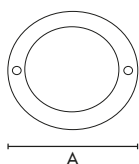

E3107/E3115 —● Inground - Garden series

Faretto LED da interramento, IP67

Ghiera esterna in acciaio inox, corpo in alluminio anti-corodal, diffusore in vetro temperato.

Driver non incluso, alimentare a 24V.

IP67 inground LED spotlight.

Stainless steel ring, anti-corodal aluminium body, tempered glass diffuser.

Driver not included, 24V in.

°K	dim A-B-C-D(mm)	CRI	Watt	Lumen	Emit °	IP grade	V in	Cod.
3000°K	Ø120-70-95-Ø100	>80	7,00	550	30°	IP67	24V	E3107WW
	Ø180-100-120-Ø162	>80	15,00	1180	30°	IP67	24V	E3115WW
4000°K	Ø120-70-95-Ø100	>80	7,00	560	30°	IP67	24V	E3107NW
	Ø180-100-120-Ø162	>80	15,00	1200	30°	IP67	24V	E3115NW

Drivers

Driver per illuminazione a led / Led lighting drivers

Led Drivers

CV led

Driver led in tensione costante / Constant voltage led drivers



FMT



RBV



BMT



LNT



APV



LPV



XLG



ELG



ELG-B



ELG-DA

CC led

Driver led in corrente costante / Constant current led drivers



APC



LPC



LCM



LCM-DA



FLS

Industrial

Driver industriali / Drivers for industrial applications



LRS



RSP



NDR



SDR



KNX

Controllers

Sistemi di controllo per led / Led controllers

Controllers

Mini Ignitions

Mini accensioni per strip led / Mini ignitions for LED strips



A3051



A3053



A3056



A3060

Controllers

Sistemi di controllo per led / Led controllers

Controllers

Professional

Controller led professionali / Professional led controllers



Push-cv

Push-4cv

Push-230

Phase-cut

Dali-cv

Dali-4cv

Dali-230v

Dali-wifi

Dmx-cv

Dmx-4cv

Radio-push

Radio-cv

Matter-cv

Matter-230

Forrest-spi

RF

Controller led in radiofrequenza / Radio frequency led controllers

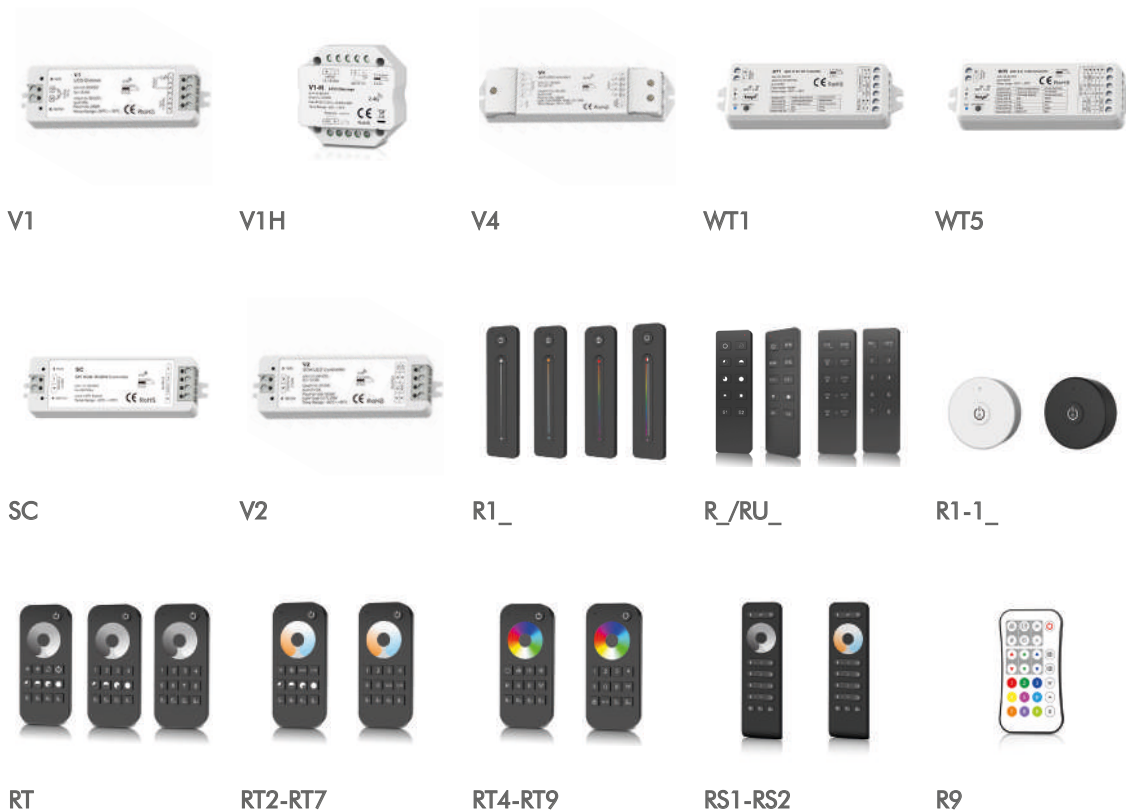

V1

V1H

V4

WT1

WT5

SC

V2

R1_

R_/RU_

R1-1_

RT_

RT2-RT7

RT4-RT9

RS1-RS2

R9

Il nostro brand di driver led / Our led driver brand

PROXIMA

Un brand di proprietà DG Tecnologie s.r.l.
Brand owned by DG Tecnologie s.r.l.

I Driver Proxima sono appositamente progettati per funzionare con Strip LED, per questo è stata riservata un'estrema attenzione al filtraggio, in modo da poter garantire una tensione in uscita priva di componenti dannosi per apparati a LED delicati come le Strip. I Driver Proxima sono anche dotati di filtro PFC "correzione del fattore di potenza", necessario per massimizzare l'efficienza delle apparecchiature. La sua importanza è tale che esistono norme che dettano i livelli minimi per specifici tipi di apparecchiature elettroniche.

I driver Proxima sono prodotti custom, realizzati su misura in base alle specifiche fornite dai nostri tecnici. Al loro interno vengono installati condensatori maggiorati a basso ESR, circuiti integrati speciali e componenti che consentano di ottenere un grado di isolamento superiore allo standard.

Proxima Drivers are specially designed to work with LED Strips, for this reason extreme attention has been paid to filtering, in order to guarantee an output voltage free of harmful components for delicate LED devices such as Strips. Proxima drivers are also equipped with a PFC "power factor correction" filter, necessary to maximize the efficiency of the equipment. Its importance is such that there are standards that dictate minimum levels for specific types of electronic equipment.

Proxima drivers are custom products, made to measure according to the specifications provided by our technicians. Inside they are installed increased capacitors with low ESR, special integrated circuits and components that allow to obtain a degree of insulation higher than the standard.

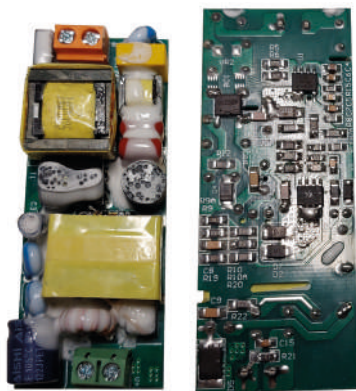

Driver Proxima serie slim FMT
Proxima driver slim series FMT

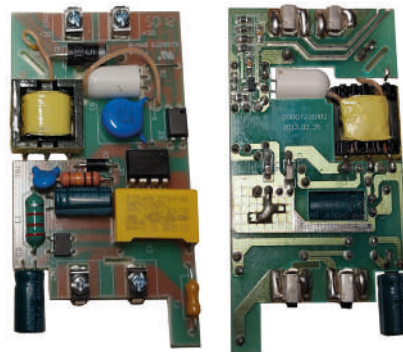

Altri driver slim di brand comparabili
Other slim drivers from comparable brands

Soluzioni su misura / Tailor made solutions

I driver led Proxima possono essere forniti con sistemi di cablaggio personalizzati, come connettori, splitter box o cavi già collegati e tagliati a misura.

Proxima led drivers can be supplied with customized wiring systems, such as connectors, splitter boxes or cables already connected and cut to size.

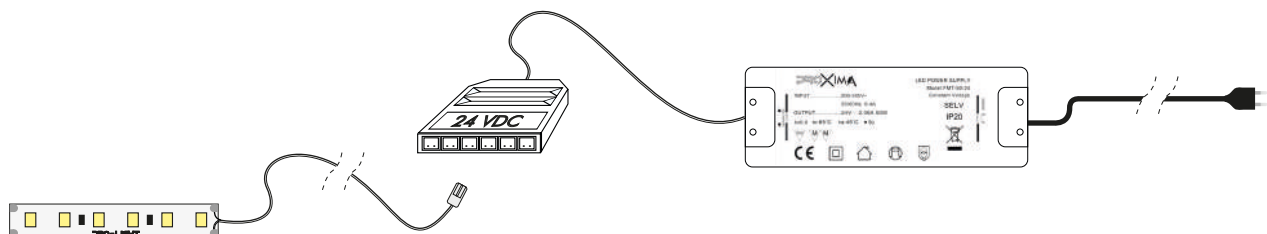

ON/OFF

PROXIMA



FMT series - Slim IP20 - ON/OFF

Cod.	Power	V in.	V. out	Current	Dim. (mm)
FMT-15-24	15W	220 - 240Vac	24V	0,65A	103 x 35 x 17
FMT-20-24	20W	220 - 240Vac	24V	0,83A	103 x 35 x 17
FMT-30-24	30W	220 - 240Vac	24V	1,25A	160 x 58 x 18
FMT-50-24	50W	220 - 240Vac	24V	2,08A	160 x 58 x 18
FMT-75-24	75W	220 - 240Vac	24V	3,125A	160 x 58 x 18
FMT-100-24	100W	220 - 240Vac	24V	4,16A	160 x 58 x 18
FMT-150-24	150W	220 - 240Vac	24V	6,25A	179 x 58 x 20

PROXIMA



RBV series - Plastic IP67 - ON/OFF

Cod.	Power	V in.	V. out	Current	Dim. (mm)
RBV-6-24	6W	220 - 240Vac	24V	0,25A	55 x 30 x 24
RBV-12-24	12W	220 - 240Vac	24V	0,50A	56 x 39 x 26
RBV-18-24	18W	220 - 240Vac	24V	0,75A	130 x 25 x 21
RBV-20-24	20W	220 - 240Vac	24V	0,83A	64 x 48 x 28
RBV-40-24	40W	220 - 240Vac	24V	1,66A	148 x 40 x 30
RBV-60-24	60W	220 - 240Vac	24V	2,50A	163 x 43 x 33
RBV-80-24	80W	220 - 240Vac	24V	3,33A	190 x 52 x 37
RBV-100-24	100W	220 - 240Vac	24V	4,16A	190 x 52 x 37
RBV-150-24	150W	220 - 240Vac	24V	6,25A	191 x 68 x 37
RBV-200-24	200W	220 - 240Vac	24V	8,33A	191 x 68 x 37

PROXIMA



BMT series - Plastic IP20 - ON/OFF

Cod.	Power	V in.	V. out	Current	Dim. (mm)
BMT-12-24	12W	220 - 240Vac	24V	0,50A	82 x 36 x 24
BMT-30-24	30W	220 - 240Vac	24V	1,25A	147 x 48 x 24
BMT-60-24	60W	220 - 240Vac	24V	2,50A	185 x 64 x 22
BMT-80-24	80W	220 - 240Vac	24V	3,33A	170 x 57 x 32
BMT-100-24	100W	220 - 240Vac	24V	4,16A	180 x 66 x 32
BMT-150-24	150W	220 - 240Vac	24V	6,25A	205 x 71 x 35
BMT-200-24	200W	220 - 240Vac	24V	8,33A	205 x 71 x 35
BMT-320-24	320W	220 - 240Vac	24V	13,4A	210 x 80 x 36

PROXIMA



LNT series - Ballast IP20 - ON/OFF

Cod.	Power	V in.	V. out	Current	Dim. (mm)
LNT-75-24	75W	220 - 240Vac	24V	3,125A	305 x 30 x 17
LNT-100-24	100W	220 - 240Vac	24V	4,16A	305 x 30 x 17

ON/OFF

APV series - Plastic IP42 - ON/OFF



Cod.	Power	V in.	V. out	Current	Dim. (mm)
APV-12-12	12W	90 - 264Vac	12V	1A	60 x 30 x 23,5
APV-12-24	12W	90 - 264Vac	24V	0,5A	60 x 30 x 23,5
APV-35-12	35W	90 - 264Vac	12V	3A	84 x 57 x 29,5
APV-35-24	35W	90 - 264Vac	24V	1,5A	84 x 57 x 29,5

LPV series - Plastic IP67 - ON/OFF



Cod.	Power	V in.	V. out	Current	Dim. (mm)
LPV-20-12	20W	90 - 264Vac	12V	1,67A	118 x 35 x 26
LPV-20-24	20W	90 - 264Vac	24V	0,84A	118 x 35 x 26
LPV-35-12	35W	90 - 264Vac	12V	3A	148 x 40 x 30
LPV-35-24	35W	90 - 264Vac	24V	1,5A	148 x 40 x 30
LPV-60-5	60W	90 - 264Vac	5V	8A	163 x 43 x 32
LPV-60-12	60W	90 - 264Vac	12V	5A	163 x 43 x 32
LPV-60-24	60W	90 - 264Vac	24V	2,5A	163 x 43 x 32
LPV-100-5	100W	90 - 264Vac	5V	12A	190 x 52 x 37
LPV-100-12	100W	90 - 264Vac	12V	8,5A	190 x 52 x 37
LPV-100-24	100W	90 - 264Vac	24V	4,2A	190 x 52 x 37
LPV-150-12	150W	180 - 305Vac	12V	10A	191 x 63 x 37,5
LPV-150-24	150W	180 - 305Vac	12V	6,3A	191 x 63 x 37,5

XLG series - Metallic IP67 - ON/OFF



Cod.	Power	V in.	V. out	Current	Dim. (mm)
XLG-100-12-A	100W	100 - 305Vac	24V	8,33A	140 x 63 x 32
XLG-100-24-A	100W	100 - 305Vac	24V	4,16A	140 x 63 x 32
XLG-150-12-A	150W	100 - 305Vac	12V	12,5A	180 x 63 x 35
XLG-150-24-A	150W	100 - 305Vac	24V	6,25A	180 x 63 x 35
XLG-200-12-A	200W	100 - 305Vac	12V	16,6A	199 x 63 x 35
XLG-200-24-A	200W	100 - 305Vac	24V	8,33A	199 x 63 x 35

ELG series - Metallic IP67 - ON/OFF



Cod.	Power	V in.	V. out	Current	Dim. (mm)
ELG-75-24-3Y	75W	100 - 305Vac	24V	3,15A	180 x 63 x 36
ELG-100-24-3Y	100W	100 - 305Vac	24V	4A	199 x 63 x 36
ELG-150-24-3Y	150W	100 - 305Vac	24V	6,25A	219 x 63 x 36
ELG-200-24-3Y	200W	100 - 305Vac	24V	8,4A	244 x 71 x 36
ELG-240-24-3Y	240W	100 - 305Vac	24V	10A	244 x 71 x 36

0-10



ELG-B series - Metallic IP67 - 0-10

Cod.	Power	V in.	V. out	Current	Dim. (mm)
ELG-75-24B-3Y	75W	100 - 305Vac	24V	3,15A	180 x 63 x 36
ELG-100-24B-3Y	100W	100 - 305Vac	24V	4A	199 x 63 x 36
ELG-150-24B-3Y	150W	100 - 305Vac	24V	6,25A	219 x 63 x 36
ELG-200-24B-3Y	200W	100 - 305Vac	24V	8,4A	244 x 71 x 36
ELG-240-24B-3Y	240W	100 - 305Vac	24V	10A	244 x 71 x 36

DALI



ELG-DA series - Metallic IP67 - DALI

Cod.	Power	V in.	V. out	Current	Dim. (mm)
ELG-75-24DA-3Y	75W	100 - 305Vac	24V	3,15A	180 x 63 x 36
ELG-100-24DA-3Y	100W	100 - 305Vac	24V	4A	199 x 63 x 36
ELG-150-24DA-3Y	150W	100 - 305Vac	24V	6,25A	219 x 63 x 36
ELG-200-24DA-3Y	200W	100 - 305Vac	24V	8,4A	244 x 71 x 36
ELG-240-24DA-3Y	240W	100 - 305Vac	24V	10A	244 x 71 x 36

ON/OFF

APC series - Plastic IP42 - ON/OFF



Cod.	Power range	V in.	Current out	Dim. (mm)
APC-8-350	4-8W	90 - 264Vac	350mA	118 x 35 x 26
APC-8-700	4-8W	90 - 264Vac	700mA	118 x 35 x 26
APC-12-350	3-12W	90 - 264Vac	350mA	118 x 35 x 26
APC-12-700	6-13W	90 - 264Vac	700mA	118 x 35 x 26
APC-16-350	4-17W	90 - 264Vac	350mA	118 x 35 x 26
APC-16-700	6-17W	90 - 264Vac	700mA	118 x 35 x 26
APC-25-350	9-25W	90 - 264Vac	350mA	118 x 35 x 26
APC-25-700	8-25W	90 - 264Vac	700mA	118 x 35 x 26
APC-35-350	10-35W	90 - 264Vac	350mA	118 x 35 x 26
APC-35-700	11-35W	90 - 264Vac	700mA	118 x 35 x 26

LPC series - Plastic IP67 - ON/OFF



Cod.	Power range	V in.	Current out	Dim. (mm)
LPC-20-350	3-17W	90 - 264Vac	350mA	118 x 35 x 26
LPC-20-700	6-21W	90 - 264Vac	700mA	118 x 35 x 26
LPC-35-700	6-34W	90 - 264Vac	700mA	148 x 40 x 30

0-10



LCM series - Plastic IP42 - 0-10

Cod.	Power	V in.	Current out (mA)	Dim. (mm)
LCM-25	25W	180 - 277Vac	350-500-600-700-900-1050	105 x 68 x 23
LCM-40	40W	180 - 295Vac	350-500-600-700-900-1050	123,5 x 81,5 x 23
LCM-60	60W	180 - 295Vac	500-600-700-900-1050-1400	123,5 x 81,5 x 23

Accessori / Accessories

Cod.	Descr.
LCM-CAV1	Cavo di sincronia per LCM-25 100cm Sync cable for LCM-25 100cm
LCM-CAV	Cavo di sincronia per LCM-40 e LCM-60 100cm Sync cable for LCM-40 and LCM-60 100cm

DALI/PUSH



LCM DA series - Plastic IP42 - DALI PUSH

Cod.	Power	V in.	Current out (mA)	Dim. (mm)
LCM-25DA2	25W	180 - 277Vac	350-500-600-700-900-1050	105 x 68 x 23
LCM-40DA2	40W	180 - 295Vac	350-500-600-700-900-1050	123,5 x 81,5 x 23
LCM-60DA2	60W	180 - 295Vac	500-600-700-900-1050-1400	123,5 x 81,5 x 23

Accessori / Accessories

Cod.	Descr.
LCM-CAV1	Cavo di sincronia per LCM-25DA2 100cm Sync cable for LCM-25DA2 100cm
LCM-CAV	Cavo di sincronia per LCM-40DA2 e LCM-60DA2 100cm Sync cable for LCM-40DA2 and LCM-60DA2 100cm

FLS series - Plastic IP20 - DALI PUSH



Cod.	Power range	V in.	Current out (mA)	Dim. (mm)
FLS-12-350DALI2-LD	3-12W	220 - 240Vac	120-150-180-200-250-280-300-350	142 x 45 x 30
FLS-26-700DALI2-LD1	3-26W	220 - 240Vac	150-200-250-300-350-400-450-500-550-600-650-700	131 x 43 x 30
FLS-44-1050DALI2-LD	20-44W	220 - 240Vac	700-750-800-850-900-950-1000-1050	131 x 43 x 30

ON/OFF

LRS series - Metallic IP20 - ON/OFF



Cod.	Power	V in.	V. out	Current	Dim. (mm)
LRS-35-12	35W	85 - 264Vac	12V	3A	99 x 82 x 30
LRS-35-24	35W	85 - 264Vac	24V	1,5A	99 x 82 x 30
LRS-50-12	50W	85 - 264Vac	12V	4,2A	99 x 82 x 30
LRS-50-24	50W	85 - 264Vac	24V	2,1A	99 x 82 x 30
LRS-75-12	75W	85 - 264Vac	12V	6A	99 x 97 x 30
LRS-75-24	75W	85 - 264Vac	24V	3,2A	99 x 97 x 30
LRS-100-12	100W	85 - 264Vac	12V	8,5A	129 x 97 x 30
LRS-100-24	100W	85 - 264Vac	24V	4,5A	129 x 97 x 30
LRS-150-12	150W	85 - 264Vac	12V	12,5A	159 x 97 x 30
LRS-150-24	150W	85 - 264Vac	24V	6,5A	159 x 97 x 30

RSP series - Metallic IP20 - ON/OFF



Cod.	Power	V in.	V. out	Current	Dim. (mm)
RSP-150-24	150W	88 - 264Vac	24V	6,3A	199 x 99 x 30
RSP-200-12	200W	88 - 264Vac	12V	16,7A	215 x 115 x 30
RSP-200-24	200W	88 - 264Vac	24V	8,4A	215 x 115 x 30

RSP series - Metallic IP20 - ON/OFF



Cod.	Power	V in.	V. out	Current	Dim. (mm)
RSP-320-12	320W	88 - 264Vac	12V	26,7A	215 x 115 x 30
RSP-320-24	320W	88 - 264Vac	24V	13,4A	215 x 115 x 30
RSP-500-12	500W	85 - 264Vac	12V	41,7A	230 x 127 x 41
RSP-500-24	500W	85 - 264Vac	24V	21A	230 x 127 x 41

ON/OFF



NDR series - Din rail IP20 - ON/OFF

Cod.	Power	V in.	V. out	Current	Dim. (mm)
NDR-75-12	75W	90 - 264Vac	12V	6,3A	32 x 125 x 102
NDR-75-12	75W	90 - 264Vac	24V	3,2A	32 x 125 x 102
NDR-120-12	120W	90 - 264Vac	12V	10A	40 x 125 x 114
NDR-120-24	120W	90 - 264Vac	24V	5A	40 x 125 x 114
NDR-240-24	240W	90 - 264Vac	24V	10A	63 x 125 x 114
NDR-480-24	480W	90 - 264Vac	24V	20A	86 x 125 x 129



SDR series - Din rail IP20 - ON/OFF

Cod.	Power	V in.	V. out	Current	Dim. (mm)
SDR-120-24	120W	85 - 264Vac	24V	5A	40 x 125 x 113,5
SDR-240-24	240W	85 - 264Vac	24V	10A	63 x 125 x 113,5
SDR-480P-24	480W	90 - 264Vac	24V	20A	86 x 125 x 128,5
SDR-960-24	960W	90 - 264Vac	24V	40A	110 x 125 x 150

KNX



KNX series - Din rail IP20

Cod.	Power	V in.	Current out	Dim. (mm)
KNX-20E-640	20W	180 - 264Vac	640mA	52,5 x 90 x 54,5

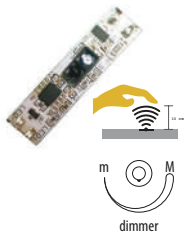

Dimmer 1 ch. - Strip 1color - Hand Sweep

Caratteristiche / Features

Dimmer touch per strip led integrate in profili in alluminio / Touch dimmer for LED strips integrated into aluminum profiles

Accensione e spegnimento con passaggio della mano a 10cm, dimming con rilevazione prolungata / Switching on and off with hand sweep at 10cm max distance, dimming with prolonged detection

Cod.	V in.	V out.	Out.	Power Out.	Control	Dim(mm)
A3051	12-24V	12-24V	1ch x 3A	1x(36-72W)	Passaggio mano Hand sweep	40x10x14

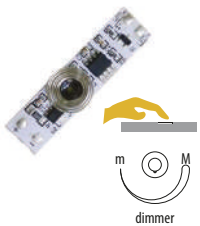

Dimmer 1 ch. - Strip 1color - Touch

Caratteristiche / Features

Dimmer touch per strip led integrate in profili in alluminio, led blu acceso quando il led è spento / Touch dimmer for LED strips integrated into aluminum profiles, blue led on when light is off

Accensione e spegnimento con tocco rapido sul diffusore del profilo, dimming con tocco prolungato / Switching on and off with a quick touch on the profile diffuser, dimming with prolonged touch

Cod.	V in.	V out.	Out.	Power Out.	Control	Dim(mm)
A3053	12-24V	12-24V	1ch x 3A	1x(36-72W)	Tocco touch Touch sensor	40x10x14



On/off sensor 1 ch. - Strip 1color - PIR

Caratteristiche / Features

Dimmer touch per strip led integrate in profili in alluminio / Touch dimmer for LED strips integrated into aluminum profiles

Accensione con rilevazione di presenza, spegnimento automatico dopo 30 secondi dall'ultima rilevazione / Switching on with presence detection, automatic switch-off after 30 seconds after last detection

Cod.	V in.	V out.	Out.	Power Out.	Control	Dim(mm)
A3056	12-24V	12-24V	1ch x 3A	1x(36-72W)	Sensore presenza PIR sensor	40x10x14



On/off sensor 1 ch. - Strip 1color - IR door

Caratteristiche / Features

Sistema di accensione ad anta battente / Door contact switch system

Installazione a superficie o ad incasso / Surface or recessed mounting

Cod.	V in.	V out.	Out.	Power Out.	Control	Dim(mm)
A3060	12-24V	12-24V	1ch x 2A	1x(24-48W)	Sensore IR IR sensor	Ø14x70

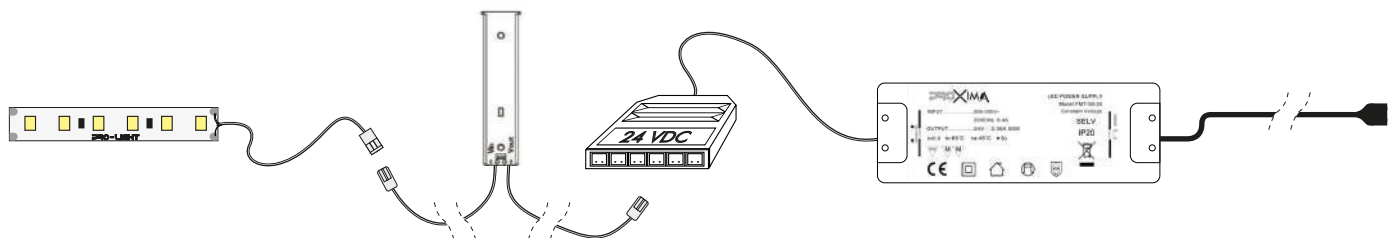
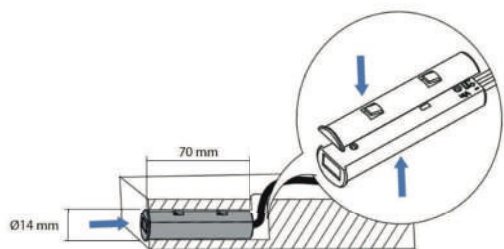

PUSH



Dimmer 1 ch. - Strip 1color - Push/0-10/1-10/Pot

Caratteristiche / Features

Menu di programmazione funzionalità / Function programming menu
 Protezione da inversione polarità e circuito aperto / Reverse polarity and open circuit protection
 Richiamo rapido intensità massima e luce soft / Quick recall of maximum intensity and soft light

Cod.	V in.	V out.	Out.	Power Out.	Control	Dim(mm)
PUSH-CV	12÷48V	12÷48V	1ch x 12A	1x(144-576W)	Push/0-10/ 1-10/Pot	48x48x23



Dimmer 4 ch. - Strip 1color/CCT/RGB/RGBW - Push/Bluetooth

Caratteristiche / Features

Gestibile tramite app e Bluetooth / Manageable via app and Bluetooth
 Protezione da inversione polarità e circuito aperto / Reverse polarity and open circuit protection
 Richiamo rapido intensità massima e luce soft / Quick recall of maximum intensity and soft light

Cod.	V in.	V out.	Out.	Power Out.	Control	Dim(mm)
PUSH-4CV	12÷48V	12÷48V	4ch x 8A tot	1x(96-384W)	Push/ Bluetooth	71x90x32



Dimmer 1 ch. - Strip 1color - Push

Caratteristiche / Features

Menu con impostazione livello minimo e curva / Menu with minimum level and curve setting
 Protezione da circuito aperto e corto circuito / Open circuit and short circuit protection
 Uscita taglio di fase con ingresso push / Phase cut output with push input

Cod.	Vac in.	Vac out.	Out.	Power Out.	Control	Dim(mm)
PUSH-230V	80÷230	80÷230	1ch	1x(230W)	Push	22x45x40

PHASE CUT



Dimmer 1 ch. - Strip 1color - Phase cut/0-10/1-10/Push pot/Dali

Caratteristiche / Features

Autoselezione modalità di input / Auto-detect input mode
 Protezione da circuito aperto e corto circuito / Open circuit and short circuit protection
 Uscita in tensione costante PWM / PWM constant voltage output

Cod.	V in.	V out.	Out.	Power Out.	Control	Dim(mm)
PHASE-CUT-CV	12÷48V	12÷48V	1ch x 12A	1x(144-576W)	Phase cut/ 0-10/1-10/ Push pot/Dali	40x80x25

DALI



Dimmer 1 ch. - Strip 1color - Dali/0-10/1-10/Push/Pot

Caratteristiche / Features

Autoselezione modalità di input / Auto-detect input mode

Protezione da inversione polarità e circuito aperto / Reverse polarity and open circuit protection

Cod.	V in.	V out.	Out.	Power Out.	Control	Dim(mm)
DALI-CV	12÷48V	12÷48V	1ch x 12A	1x(144-576W)	Dali/0-10/ 1-10/ Push/ Pot	48x48x23



Dimmer 4 ch. - Strip 1color/CCT/RGB/RGBW - Dali

Caratteristiche / Features

Protezione da inversione polarità e circuito aperto / Reverse polarity and open circuit protection

Cod.	V in.	V out.	Out.	Power Out.	Control	Dim(mm)
DALI-4CV	12÷48V	12÷48V	4ch x 8A tot	1x(96-384W)	Dali	71x90x32



Dimmer 1 ch. - Strip 1color - Wifi/Push

Caratteristiche / Features

Protezione da inversione polarità e circuito aperto / Reverse polarity and open circuit protection

Uscita taglio di fase con ingresso Dali / Phase cut output with Dali input

Cod.	Vac in.	Vac out.	Out.	Power Out.	Control	Dim(mm)
DALI-230V	110÷230	110÷230	1ch	1x(230W)	Dali/Push	40x80x25

CONVERTER



Protocol converter 1 ch. - Strip 1color - Wifi/Push

Caratteristiche / Features

Dispositivo convertitore Wifi Dali con interfaccia pulsante / Wifi Dali converter device with button interface

Uscite di sincronia Dali x1 / Dali sync outputs x1

Cod.	Vac in.	Vac out.	Out.	Power Out.	Control	Dim(mm)
DALI-WIFI	110÷230	110÷230	1ch	1x	Wifi/Push	40x80x25

DMX



Dimmer 1 ch. - Strip 1color - DMX512A RDM

Caratteristiche / Features

Dimmer con ingresso DMX512A RDM / Dimmer with DMX512A RDM input
 Protezione da inversione polarità e circuito aperto / Reverse polarity and open circuit protection

Cod.	V in.	V out.	Out.	Power Out.	Control	Dim(mm)
DMX-CV	12÷48V	12÷48V	1ch x 12A	1x(144-576W)	DMX512A RDM	40x80x25



Dimmer 4 ch. - Strip 1color/CCT/RGB/RGBW - DMX512A RDM

Caratteristiche / Features

Dimmer con ingresso DMX512A RDM / Dimmer with DMX512A RDM input
 Protezione da inversione polarità e circuito aperto / Reverse polarity and open circuit protection

Cod.	V in.	V out.	Out.	Power Out.	Control	Dim(mm)
DMX-4CV	12÷48V	12÷48V	4ch x 8A tot	1x(96-384W)	DMX512A RDM	71x90x32

RF PUSH



Transmitter 4 ch. - Push

Caratteristiche / Features

Associazione immediata ed intuitiva / Immediate and intuitive association
 Alimentabile a tensione di rete o a batteria / Can be powered by mains voltage or battery
 Comanda fino a 4 pulsanti per dimmer in radio frequenza / Controls up to 4 RF dimmer buttons

Cod.	Vac in.	Vac out.	Out.	Optional battery	Control	Dim(mm)
RADIO-PUSH-TX	110÷230 /1xCR2032	-	4ch.	1xCR2032	Push	48x48x23



Receiver 1 ch. - Strip 1color - Phase cut/0-10/1-10/Push pot/Dali

Caratteristiche / Features

Menu di programmazione funzionalità / Function programming menu
 Protezione da inversione polarità e circuito aperto / Reverse polarity and open circuit protection
 Master slave digitale / Digital master slave

Cod.	V in.	V out.	Out.	Power Out.	Control	Dim(mm)
RADIO-CV-RX	12÷48V	12÷48V	1ch x 12A	1x(144-576W)	Radio push	40x80x25

WiFi



Dimmer 1 ch. - Strip 1color - Matter WiFi/Push



Caratteristiche / Features

Compatibile con protocollo Matter / Matter protocol compatible
 Protezione da inversione polarità e circuito aperto / Reverse polarity and open circuit protection

Cod.	V in.	V out.	Out.	Power Out.	Control	Dim(mm)
MATTER-CV	12÷48V	12÷48V	1ch x 12A	1x(144-576W)	Matter WiFi/ Push	40x80x25



Dimmer 1 ch. - Strip 1color - Matter WiFi/Push



Caratteristiche / Features

Compatibile con protocollo Matter / Matter protocol compatible
 Protezione da circuito aperto e corto circuito / Open circuit and short circuit protection

Cod.	Vac in.	Vac out.	Out.	Power Out.	Control	Dim(mm)
MATTER-230V	110÷230	110÷230	1ch	1x(230W)	Matter WiFi/ Push	40x80x25

PUSH SPI



Dimmer 1 ch. - Strip Pixel to Pixel spi - 1 color/ RGB - Push

Caratteristiche / Features

Generatore show per strip led pixel to pixel / Show generator for pixel to pixel LED strips
 Lunghezza strip, direzione e velocità impostabili / Strip length, direction and speed can be set
 Effetto "run" / "Run" effect

Cod.	V in.	V out.	Out.	Power Out.	Control	Dim(mm)
FORREST-SPI	5÷24V	5÷24V	1ch x 15A	1x(75-360W)	Push	48x48x23

PUSH+RF

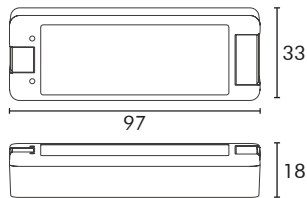

Dimmer 1 ch. - Strip 1color - Push+RF

Caratteristiche / Features

Abbinamento rapido / Quick match

Auto-trasmissione / Self-transmission

Sincronizzabile con più telecomandi / Can be synced with multiple remotes

Cod.	V in.	V out.	Out.	Power Out.	Control
V1	5÷36V	5÷36V	1ch x 8A	1x (40 - 288W)	Push + RF

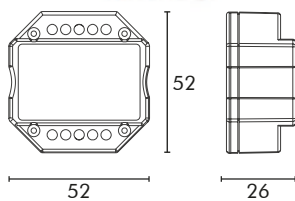

Dimmer 1 ch. - Strip 1color - Push+RF

Caratteristiche / Features

Abbinamento rapido / Quick match

Auto-trasmissione / Self-transmission

Sincronizzabile con più telecomandi / Can be synced with multiple remotes

Cod.	V in.	V out.	Out.	Power Out.	Control
V1H	12÷48V	12÷48V	1ch x 3/6A	1x (72 - 144W)	Push + RF

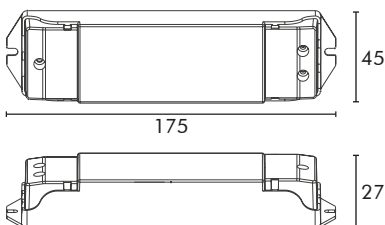

Dimmer 4 ch. - Strip 1color/CCT/RGB/RGBW - Push+RF

Caratteristiche / Features

Abbinamento rapido e auto-trasmissione / Quick match and self-transmission

Sincronizzabile con più telecomandi / Can be synced with multiple remotes

10 modalità dinamiche integrate / 10 built-in dynamic modes

Cod.	V in.	V out.	Out.	Power Out.	Control
V4	12÷36V	12÷36V	4ch x 5A	4x (60 - 180W)	Push + RF

PUSH+RF+WiFi

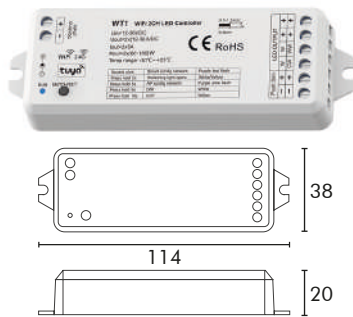

Dimmer 2 ch. - Strip 1 color/CCT - Push+RF+WiFi



Caratteristiche / Features

Abbinamento rapido e auto-trasmissione / Quick match and self-transmission
 Sincronizzabile con più telecomandi / Can be synced with multiple remotes
 Controllo da cellulare e dispositivi Amazon Echo / Control from mobile and Amazon Echo

Cod.	V in.	V out.	Out.	Power Out.	Control
WT1	12÷36V	12÷36V	2ch x 5A	1x (60 - 240W)	Push+RF+WiFi

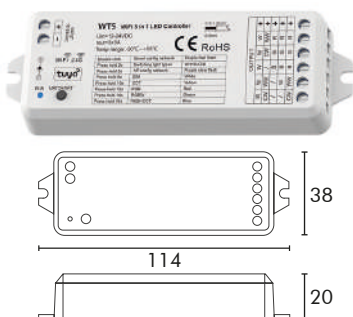

Dimmer 5 ch. - Strip RGB/RGBW/RGBCCT - Push+RF+WiFi



Caratteristiche / Features

Abbinamento rapido e auto-trasmissione / Quick match and self-transmission
 Sincronizzabile con più telecomandi / Can be synced with multiple remotes
 Controllo da cellulare e dispositivi Amazon Echo / Control from mobile and Amazon Echo

Cod.	V in.	V out.	Out.	Power Out.	Control
WT5	12÷24V	12÷24V	5ch x 3A	1x (108 - 180W)	Push+RF+WiFi

RF SPI

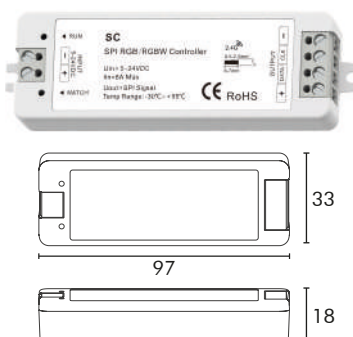

Decoder SPI - Strip SPI J5005/J5024 - RF

Caratteristiche / Features

Controllo di strip digitali indirizzabili SPI / Controls SPI addressable digital strips
 40 scenari disponibili / 40 kinds of dynamic modes available
 Sincronizzabile con più telecomandi / Can be synced with multiple remotes

Cod.	V in.	V out.	Out.	Power Out.	Control
SC	5÷24V	5÷24V	1ch x 8A	1x (40 - 192W)	RF

RF

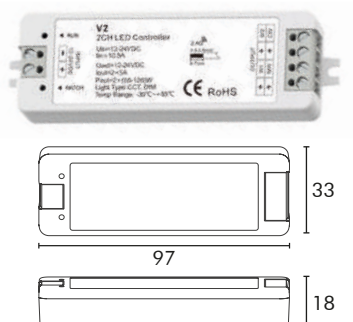

Dimmer 2 ch. - Strip CCT - RF

Caratteristiche / Features

Abbinamento rapido / Quick match
 Auto-trasmissione / Self-transmission
 Sincronizzabile con più telecomandi / Can be synced with multiple remotes

Cod.	V in.	V out.	Out.	Power Out.	Control
V2	12÷24V	12÷24V	2ch x 5A	2x (60 - 120W)	RF



R11 R12 R13 R14

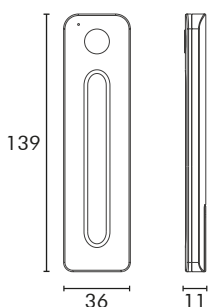

Remote RF touch slide - Strip 1color/CCT/RGB/RGBW

Caratteristiche / Features

Telecomando per controller RF / RF remote control
 Regolazione con touch a scorrimento / Sliding touch adjustment
 Retro magnetico, staffa di fissaggio inclusa / Magnetic back, fixing bracket included

Cod.	Des.	Power	Zone n°	Ch. n°
R11	Per strip 1 colore / For 1 color strip	1xCR2032	1	1
R12	Per strip CCT / For CCT strip	1xCR2032	1	2
R13	Per strip RGB / For RGB strip	1xCR2032	1	3
R14	Per strip RGBW / For RGBW strip	1xCR2032	1	4



R1 R2 RU4 RU8

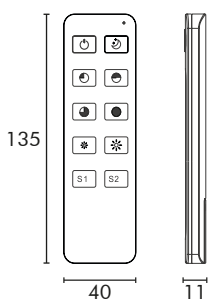

Remote RF 10 buttons - Strip 1color/CCT

Caratteristiche / Features

Telecomando per controller RF / RF remote control
 Regolazione con 10 pulsanti / 10 button adjustment
 Retro magnetico, staffa di fissaggio inclusa / Magnetic back, fixing bracket included

Cod.	Des.	Power	Zone n°	Ch. n°
R1	Per strip 1 colore / For 1 color strip	1xCR2032	1	1
R2	Per strip CCT / For CCT strip	1xCR2032	1	2
RU4	Per strip 1 colore / For 1 color strip	1xCR2032	4	1
RU8	Per strip 1 colore / For 1 color strip	1xCR2032	8	1



R1-1W

R1-1B

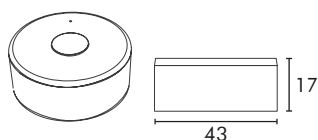

Remote RF 1 button - Strip 1 color

Caratteristiche / Features

Telecomando per controller RF / RF remote control

Regolazione con 1 pulsante / 1 button adjustment

Retro magnetico, staffa di fissaggio inclusa / Magnetic back, fixing bracket included

Cod.	Des.	Power	Zone n°	Ch. n°
R1-1W	Per strip 1 colore / For 1 color strip	1xCR2032	1	1
R1-1B	Per strip 1 colore / For 1 color strip	1xCR2032	1	1



RT1

RT6

RT8

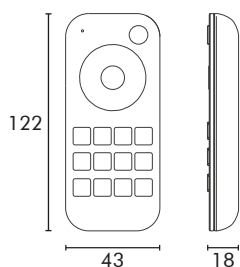

Remote RF 12 buttons + slide - Strip 1 color

Caratteristiche / Features

Telecomando per controller RF / RF remote control

Regolazione con 12 pulsanti + touch a scorrimento / 12 button adjustment + touch slide

Retro magnetico, staffa di fissaggio inclusa / Magnetic back, fixing bracket included

Cod.	Des.	Power	Zone n°	Ch. n°
RT1	Per strip 1 colore / For 1 color strip	2xAAA	1	1
RT6	Per strip 1 colore / For 1 color strip	2xAAA	4	1
RT8	Per strip 1 colore / For 1 color strip	2xAAA	8	1



RT2

RT7

Remote RF 12 buttons + slide - Strip CCT

Caratteristiche / Features

Telecomando per controller RF / RF remote control

Regolazione con 12 pulsanti + touch a scorrimento / 12 button adjustment + touch slide

Retro magnetico, staffa di fissaggio inclusa / Magnetic back, fixing bracket included

Cod.	Des.	Power	Zone n°	Ch. n°
RT2	Per strip CCT / For CCT strip	2xAAA	1	2
RT7	Per strip CCT / For CCT strip	2xAAA	4	2

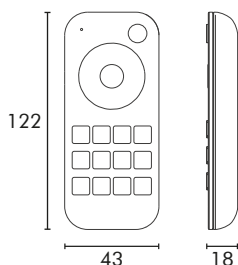

RT4

RT9

Remote RF 12 buttons + slide - Strip RGB/RGBW

Caratteristiche / Features

Telecomando per controller RF / RF remote control

Regolazione con 12 pulsanti + touch a scorrimento / 12 button adjustment + touch slide

Retro magnetico, staffa di fissaggio inclusa / Magnetic back, fixing bracket included

Cod.	Des.	Power	Zone n°	Ch. n°
RT4	Per strip RGB o RGBW / For RGB or RGBW strip	2xAAA	1	3/4
RT9	Per strip RGB o RGBW / For RGB or RGBW strip	2xAAA	4	3/4

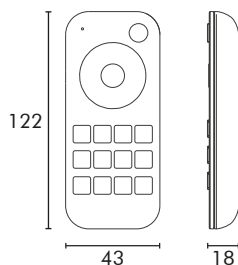



RS1

RS2

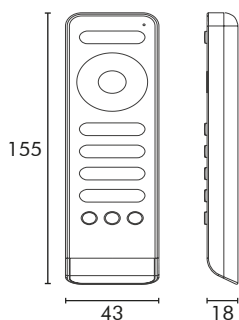

Remote RF 13 buttons + slide - Strip 1 color/CCT

Caratteristiche / Features

Telecomando per controller RF / RF remote control

Regolazione con 13 pulsanti + touch a scorrimento / 13 button adjustment + touch slide

Retro magnetico, staffa di fissaggio inclusa / Magnetic back, fixing bracket included

Cod.	Des.	Power	Zone n°	Ch. n°
RS1	Per strip 1 colore / For 1 color strip	2xAAA	4	1
RS2	Per strip CCT / For CCT strip	2xAAA	4	2



R9

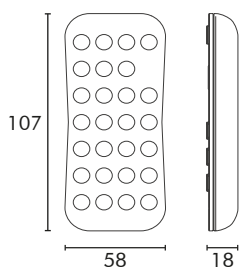

Remote RF 27 buttons - Strip RGB SPI

Caratteristiche / Features

Telecomando per controller RF / RF remote control

Regolazione con 27 pulsanti / 27 button adjustment

Staffa di fissaggio inclusa / Fixing bracket included

Cod.	Des.	Power	Zone n°	Ch. n°
R9	Per strip RGB SPI / For RGB SPI strip	1xCR2032	1	4

Contatti

Contacts

Ufficio tecnico	m.puccioni@dgtecnologie.it
Amministrazione	amministrazione@dgtecnologie.it
Commerciale	commerciale@dgtecnologie.it
Preventivi/Ordini	clienti@dgtecnologie.it

Technical office	m.puccioni@dgtecnologie.it
Administration	amministrazione@dgtecnologie.it
Sales	commerciale@dgtecnologie.it
Quotes/Orders	clienti@dgtecnologie.it

PRO-LIGHT

Pro-Light | © DG Tecnologie s.r.l.

www.pro-light.it

PROXIMA

Proxima | © DG Tecnologie s.r.l.

www.proximadriver.it

DG Tecnologie s.r.l.

Via Salvo D'Acquisto 42/F | 56025 Pontedera (PI) Italy

Tel. (+39) 0587 544 68

Tutti i diritti sono riservati. È vietata la riproduzione di testi e immagini.
All rights reserved. Reproduction of texts and images is prohibited.

PRO-LIGHT

Pro-Light | © DG Tecnologie s.r.l.

www.pro-light.it

PROXIMA

Proxima | © DG Tecnologie s.r.l.

www.proximadriver.it

DG Tecnologie s.r.l.

Via Salvo D'Acquisto 42/F | 56025 Pontedera (PI) Italy
Tel. (+39) 0587 544 68